

## Night School 27: Fundamentals of Welding and Bolting

Thank you for joining our live  
webinar. We will begin shortly.  
Please standby.

**AISC**  
Night School



**Session 1 – Introduction and Welding Processes**  
September 27, 2021 | Curtis Decker



**Smarter.  
Stronger.  
Steel.**

## AISC Live Webinars

**Today's live webinar will begin shortly. Please stand by.**

Today's audio will be broadcast through the internet. Please be sure to turn up the volume on your speakers.

Please type any questions or comments in the Q&A window.



## AISC Live Webinars

---

### AIA Credit

AISC is a Registered Provider with The American Institute of Architects Continuing Education Systems (AIA/CES). Credit(s) earned on completion of this program will be reported to AIA/CES for AIA members. Certificates of Completion for both AIA members and non-AIA members are available upon request.

This program has been submitted for AIA/CES for continuing professional education. As such, it does not include content that may be deemed or construed to be an approval or endorsement by the AIA of any material of construction or any method or manner of handling, using, distributing, or dealing in any material or product.

Questions related to specific materials, methods, and services will be addressed at the conclusion of this presentation.



## AISC Live Webinars

---

### Copyright Materials

This presentation is protected by US and International Copyright laws. Reproduction, distribution, display and use of the presentation without written permission of AISC is prohibited.

© The American Institute of Steel Construction 2021

The information presented herein is based on recognized engineering principles and is for general information only. While it is believed to be accurate, this information should not be applied to any specific application without competent professional examination and verification by a licensed professional engineer. Anyone making use of this information assumes all liability arising from such use.



## AISC Live Webinars

---

### Course Description

#### **NS27.1 – Welding Part 1 Introduction and Welding Processes September 27, 2021**

This session will consist of a review of applicable welding codes, the basics of welded joints and weld types, and required weld metal strength levels. Details for welded connection details will be discussed, including the basic criteria to be used to determine weld throat dimensions.



## AISC Live Webinars

---

### Learning Objectives

- Identify standards related to welding.
- Compare and contrast various arc welding processes.
- Define various welding and thermal cutting processes.
- Compare and contrast various joints and weld types.



## Night School 27: Fundamentals of Welding and Bolting



Curtis L. Decker, PhD, PE,  
SE, The Lincoln Electric  
Company



Duane K. Miller, PE, ScD,  
The Lincoln Electric  
Company



Chad Larson, LeJeune  
Bolt Company



Smarter.  
Stronger.  
Steel.

## Night School 27: Fundamentals of Welding and Bolting

Welding Part 1: Introduction and Welding Processes  
September 27, 2021

Curtis L. Decker, PhD, PE, SE, The Lincoln Electric Company



Smarter.  
Stronger.  
Steel.

AISC Design Guide 21, 2<sup>nd</sup> Edition

**Welded Connections—  
A Primer for Engineers**

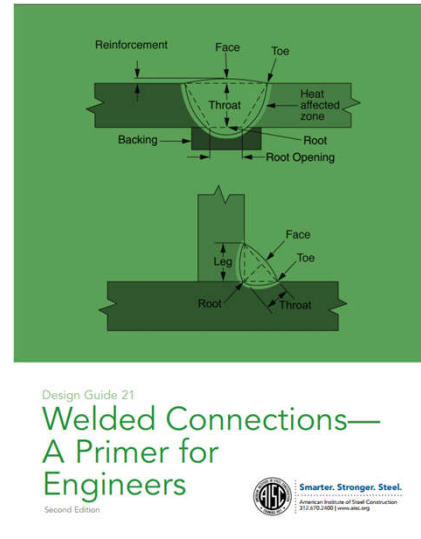

**WELDED CONNECTIONS—A PRIMER FOR ENGINEERS**

**Chapter 1: Introduction**

- 1.1 Importance of Welding
- 1.2 Scope of Welding
- 1.3 Welding-Related Codes and Specifications

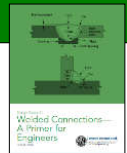

## WELDED CONNECTIONS—A PRIMER FOR ENGINEERS



### Chapter 2: Welding and Thermal Cutting Processes

- 2.1 Introduction
- 2.2 SMAW
- 2.3 FCAW
- 2.4 SAW
- 2.5 GMAW
- 2.6 ESW/EGW
- 2.7 GTAW



11

## WELDED CONNECTIONS—A PRIMER FOR ENGINEERS



### Chapter 2: Welding and Thermal Cutting Processes

- 2.8 Arc Stud Welding
- 2.9 Thermal Cutting Processes
- 2.10 Water Jet Cutting



12

## WELDED CONNECTIONS—A PRIMER FOR ENGINEERS



### Chapter 3: Welded Connection Basics

- 3.1 Joints
- 3.2 Weld Types—General
- 3.3 Complete-Joint-Penetration Groove Welds
- 3.4 Partial-Joint-Penetration Groove Welds
- 3.5 Fillet Welds
- 3.6 Plug/Slot Welds
- 3.7 Puddle Welds



13

## WELDED CONNECTIONS—A PRIMER FOR ENGINEERS



### Chapter 3: Welded Connection Basics

- 3.8 Interaction of Joint Types and Weld Types
- 3.9 Selection of Weld Types
- 3.10 Required Filler Metal Strength
- 3.11 Determining Weld Strength
- 3.12 Specific Requirements for Various Joints
- 3.13 Weld Symbols



14

## WELDED CONNECTION BASICS

### Outline

- Applicable Codes
- Arc Welding Processes – Overview
- Welding and Thermal Cutting Processes
- Joints and Weld Types



15

## WELDED CONNECTION BASICS

### Outline

- ➔ • Applicable Codes
- Arc Welding Processes – Overview
- Welding and Thermal Cutting Processes
- Joints and Weld Types



16

**AWS D1.1**

Structural Welding Code –  
Steel

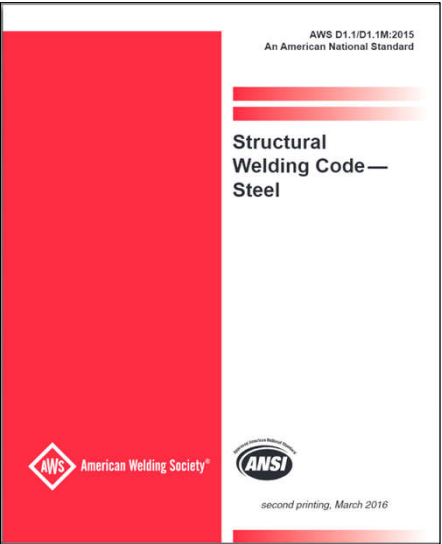

17

**AWS D1.1: 2020 Structural Welding Code – Steel**



**Major sections of AWS D1.1 include the following:**

- Clause 1 – General Requirements
- Clause 2 – Normative References
- Clause 3 – Terms and Definitions
- Clause 4 – Design of Welded Connections
- Clause 5 - Prequalification of WPSs
- Clause 6 - Qualification



18

## AWS D1.1: 2020 Structural Welding Code – Steel



**Major sections of AWS D1.1 include the following:**

- Clause 7 – Fabrication
- Clause 8 – Inspection
- Clause 9 – Stud Welding
- Clause 10 – Tubular Structures
- Clause 11 – Strengthening and Repair of Existing Structures



19

## AWS D1.3

Structural Welding Code –  
Sheet Steel

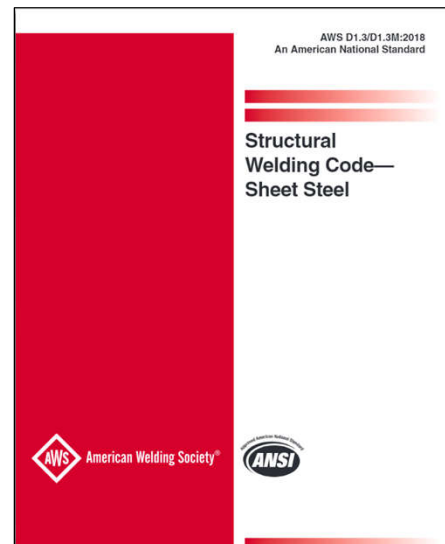

20

## AWS D1.3: 2018 Structural Welding Code – Sheet Steel



### AWS D1.3 covers:

- Welding of structural sheet and strip steels, including cold-formed members equal to or less than 3/16 in. [5mm] thick.
- The primary purpose for structural steel applications: welding sheet steel decking to supporting members with puddle welds.



21

## AWS D1.4

Structural Welding Code –  
Steel Reinforcing Bars

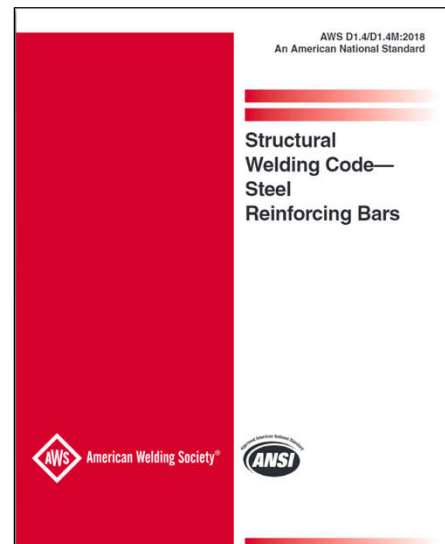

22

## AWS D1.4: 2018 Structural Welding Code – Steel Reinforcing Bars



### AWS D1.4 covers:

- Welding of reinforcing steel (rebar) to itself
- Welding of rebar to plate or shapes, including embed plates and steel used in composite construction



23

## AASHTO/AWS D1.5

### Bridge Welding Code

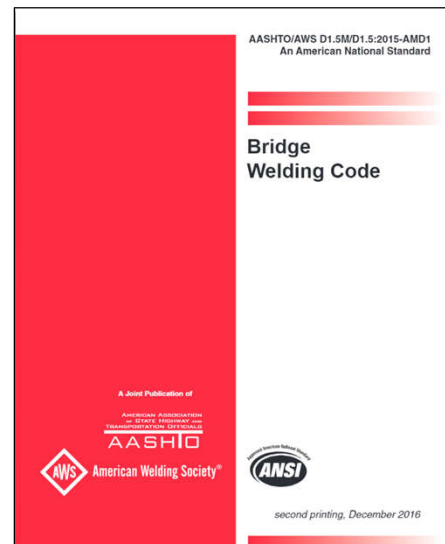

24

## AASHTO/AWS D1.5: 2020 Bridge Welding Code



### AASHTO/AWS D1.5:

- Joint standard of the AWS and the American Association of State Highway Transportation Officials (AASHTO)
- Generally requires that WPS be qualified by test, with a few exceptions
- Qualification testing involves Charpy V-notch (CVN) specimens and all weld metal tensile specimens
- Nondestructive testing (NDT) requirements



25

## AWS D1.6

Structural Welding Code –  
Stainless Steel

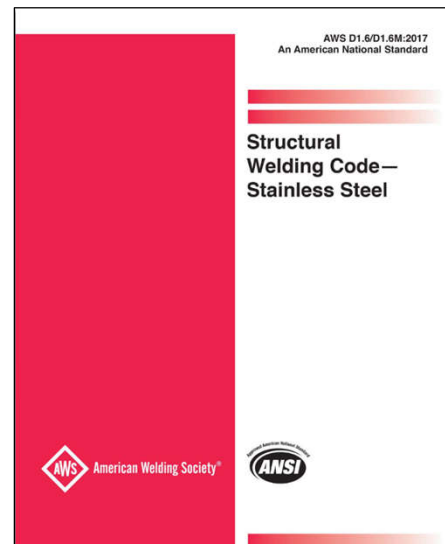

26

## AWS D1.6: 2017 Structural Welding Code – Stainless Steel



### AWS D1.6 covers:

- Requirements for welding various grades of stainless to stainless, as well as stainless to carbon steel



27

## AWS D1.7

Guide for Strengthening and Repairing  
Existing Structures

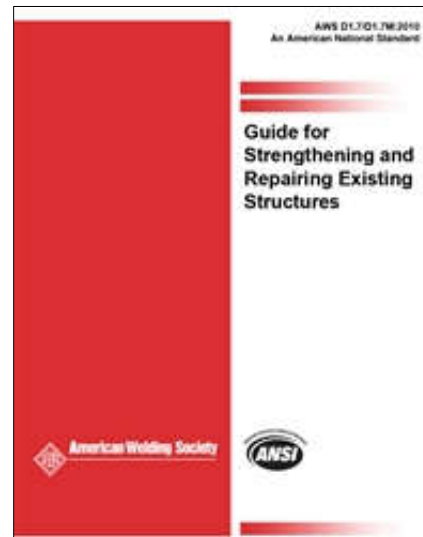

28

## AWS D1.7: 2010 Guide for Strengthening and Repairing Existing Structures



### AWS D1.7:

- D1.1 requires the Engineer to “establish a comprehensive plan for the work”: D1.7 can provide guidance
- Not a code, but a guide
- Provides guidance on: weldability, evaluation of existing welds, testing and sampling, heat strengthening, strengthening and damage repair



29

## AWS D1.8

Structural Welding Code –  
Seismic Supplement



30

## AWS D1.8: 2016 Structural Welding Code – Seismic Supplement



### AWS D1.8:

- Supplements AWS D1.1
- When AWS D1.8 is specified, all the provisions of AWS D1.1 still apply, unless modified or superseded by AWS D1.8
- Assumes that the structure is designed with AISC *Seismic Provisions*



31

## AISC 360-16

### Specification for Structural Steel Buildings

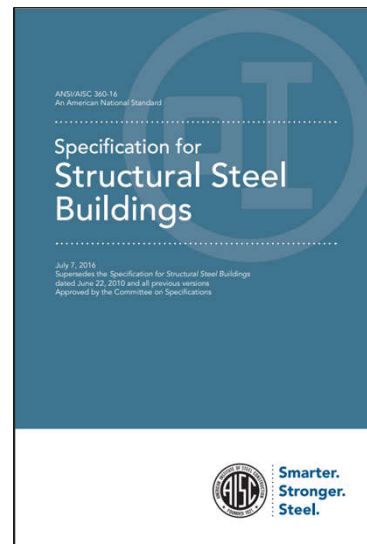

32

## AISC 360-16 Specification for Structural Steel Buildings



### **AISC 360 addresses the following major welding-related items:**

- Acceptable steel designations (Section A3.1)
- Acceptable filler metals (Section A3.5)
- Requirements for splices in heavy sections (Section J1.5)
- Beam copes and weld access holes (Section J1.6)
- Welds in combination with bolts (Section J1.8)
- Details of groove welds (Section J2.2)
- Details of fillet welds (Section J2.2)



33

## AISC 360-16 Specification for Structural Steel Buildings



### **AISC 360 addresses the following major welding-related items:**

- Available strength of welded joints (Table J2.5)
- Shop fabrication/welding issues (Section M2)
- Field erection/welding issues (Section M4)
- Weld quality control and quality assurance issues (Chapter N)
- Weld details for fatigue (Appendix 3)
- Welding issues associated with existing structures (Appendix 5)



34

**AISC 341-16**

Seismic Provisions for Structural Steel  
Buildings

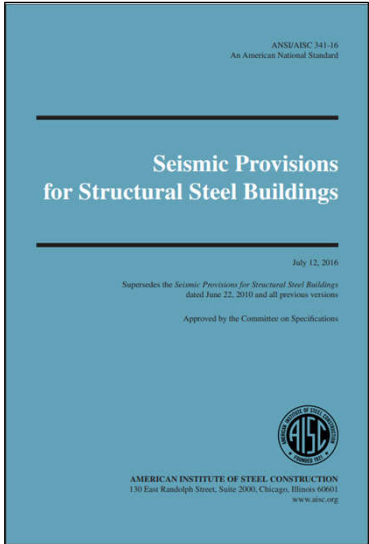

35



**AISC 341-16 Seismic Provisions for Structural Steel Buildings**

**AISC 341:**

- Developed to augment the *AISC Specification*
- Adds provisions deemed necessary for high-seismic applications, where steel members are required to dissipate energy through controlled inelastic deformations in major seismic events
- For welding-related issues, primarily refers to D1.8
- Contains “grocery list” of items to be specified in contract documents, including many welding-related issues



36



## AISC 358-16

### Prequalified Connections for Special and Intermediate Steel Moment Frames for Seismic Applications

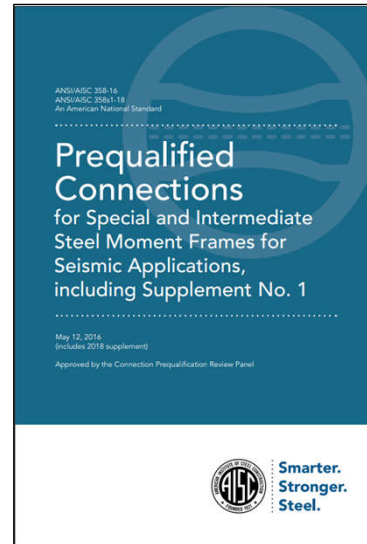

37

## AISC 358-16 Prequalified Connections for Special and Intermediate Steel Moment Frames for Seismic Applications



### AISC 358:

- Specifies design, detailing, fabrication, and quality criteria for connections that are prequalified in accordance with AISC *Seismic Provisions*
- For use with special moment frames (SMF) and intermediate moment frames (IMF)
- For welding-related issues, primarily refers to AISC 341
- Some prequalified connections have unique welded detail requirements (WUF-W, Endplate)



38

**AISC 303-16**

Code of Standard Practice for Steel  
Buildings and Bridges

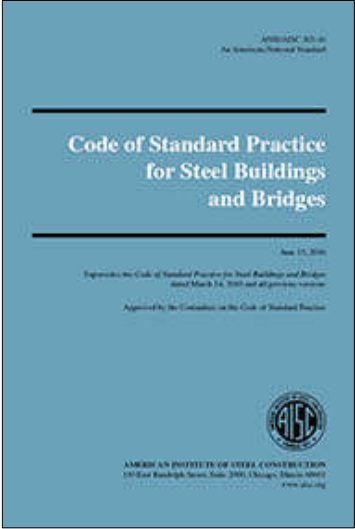



39

**AISC 303-16 Seismic Provisions for Structural Steel Buildings**

**AISC 303 addresses these major welding-related issues:**

- Overall tolerances of fabricated members and erected assemblies
- Basic tolerances for architecturally exposed structural steel (AESS)



40

## Welding-Related Codes and Specifications



### Other AWS D1 Codes:

- AWS D1.2/D1.2M *Structural Welding Code — Aluminum*
- AWS D1.9/D1.9M *Structural Welding Code — Titanium*



41

## Welding-Related Codes and Specifications



### Other AWS Standards:

- AWS A5 *Filler Metal Specifications*
- AWS A2.4 *Standard Symbols for Welding, Bracing, and Nondestructive Examination*
- AWS A3.0/A3.0M *Standard Welding Terms and Definitions*



42

## WELDED CONNECTION BASICS

### Outline

- Applicable Codes
- ➔ • Arc Welding Processes – Overview
- Welding and Thermal Cutting Processes
- Joints and Weld Types



43

## AWS STANDARD WELDING TERMS & DEFINITIONS (A3.0:2010)



### **weld.**

A localized coalescence of metals or nonmetals produced by heating the materials to the welding temperature, with or without the application of pressure, or by the application of pressure alone and with or without the use of filler metal.



44

### Arc Welding Processes



Welded Connections  
A Primer for  
Engineers

**Requirements for fusion:**

- Atomic closeness
- Atomic cleanliness



45

### Arc Welding Processes

#### Atomic Closeness

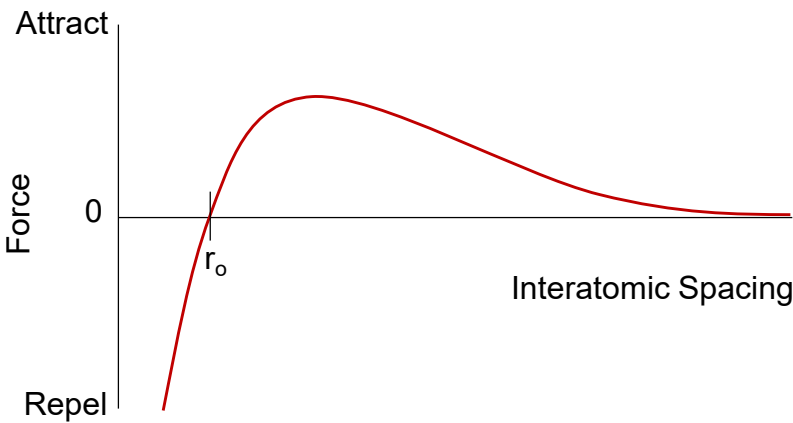

Adapted from W.F. Savage, as presented in *Weld Imperfections*, 1968



46

### Arc Welding Processes

#### Atomic Closeness

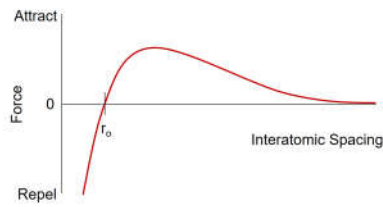
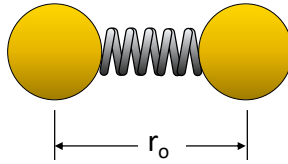

47

### Arc Welding Processes

#### Atomic Closeness

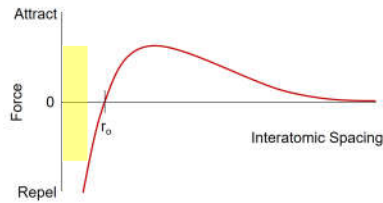
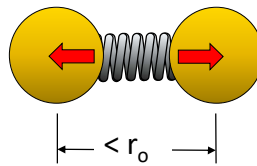

48

### Arc Welding Processes

#### Atomic Closeness

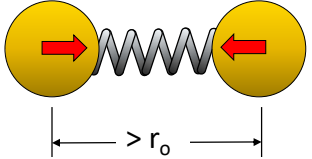

A diagram showing two yellow spheres representing atoms. A grey spring connects them, indicating a repulsive force. A horizontal double-headed arrow below the spheres is labeled  $> r_o$ , indicating the interatomic spacing is greater than the equilibrium distance.

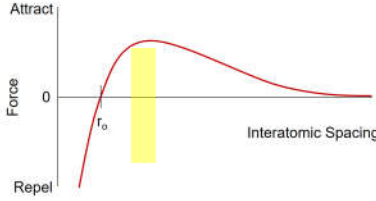

A graph with 'Force' on the vertical axis and 'Interatomic Spacing' on the horizontal axis. The vertical axis has 'Attract' at the top, '0' in the middle, and 'Repel' at the bottom. A red curve starts in the 'Repel' region, crosses the zero line at a point labeled  $r_o$ , reaches a peak in the 'Attract' region, and then gradually approaches the zero line from above. A yellow vertical bar is positioned to the right of the peak.

49

### Arc Welding Processes

#### Atomic Closeness

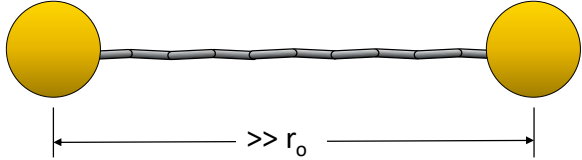

A diagram showing two yellow spheres representing atoms. A long, thin grey spring connects them, indicating a very weak repulsive force. A horizontal double-headed arrow below the spheres is labeled  $>> r_o$ , indicating the interatomic spacing is much greater than the equilibrium distance.

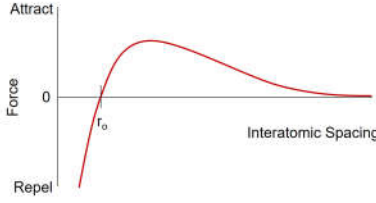

A graph with 'Force' on the vertical axis and 'Interatomic Spacing' on the horizontal axis. The vertical axis has 'Attract' at the top, '0' in the middle, and 'Repel' at the bottom. A red curve starts in the 'Repel' region, crosses the zero line at a point labeled  $r_o$ , reaches a peak in the 'Attract' region, and then gradually approaches the zero line from above. A yellow vertical bar is positioned to the right of the peak.

50

## Arc Welding Processes



### Atomic Closeness:

- Very, very close
- Gaps exist between materials, even carefully machined parts (typically 100-1000 atom diameters from peak to valley of carefully machined parts)



51

## Arc Welding Processes



### How to Achieve Atomic Closeness:

- Melt one material (brazing, soldering)
- Melt two or more materials (arc welding, resistance welding)
- Use pressure (with or without heat) to force closeness (forge welding, friction stir welding)



52

## Arc Welding Processes

### Atomic Cleanliness:

- Oxides form very rapidly
- Oxides neutralize the attractive forces
- Other contaminants: water, oil, gasses



53



## Arc Welding Processes

### How to Achieve Atomic Cleanliness:

- Mechanically clean the part (scraping, machining)
- Chemically clean the part (fluxes)



54



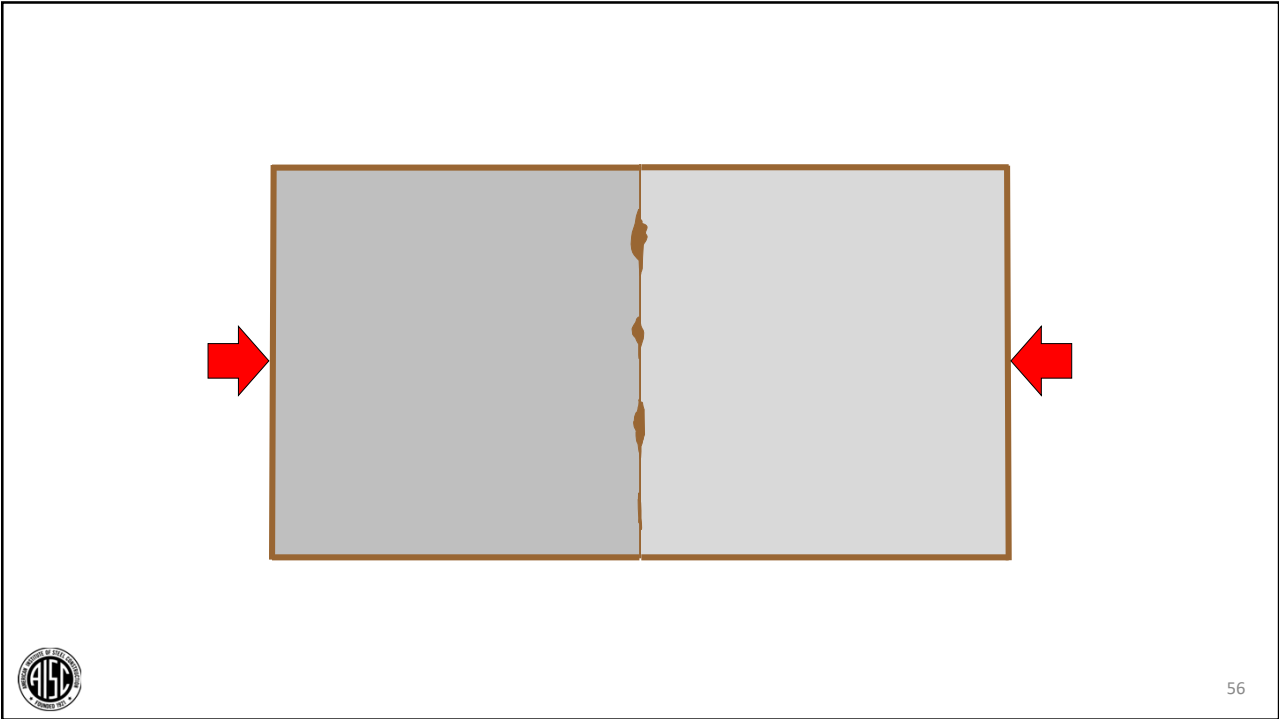
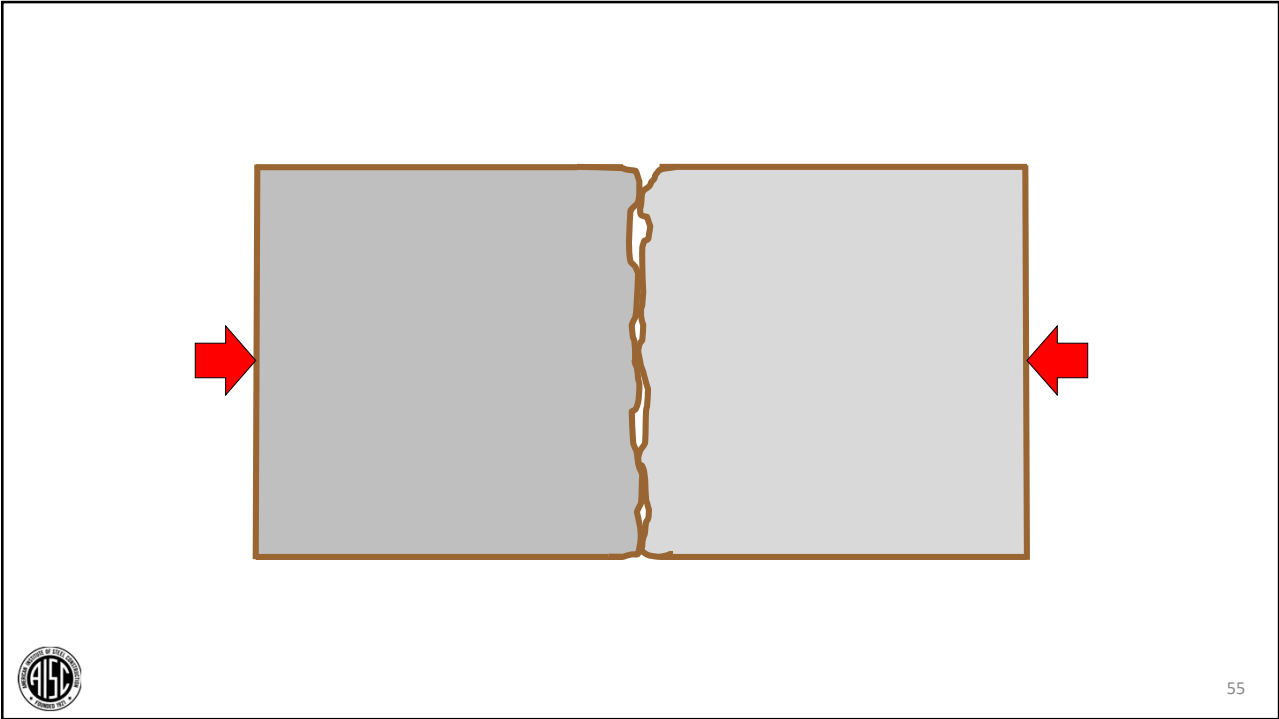

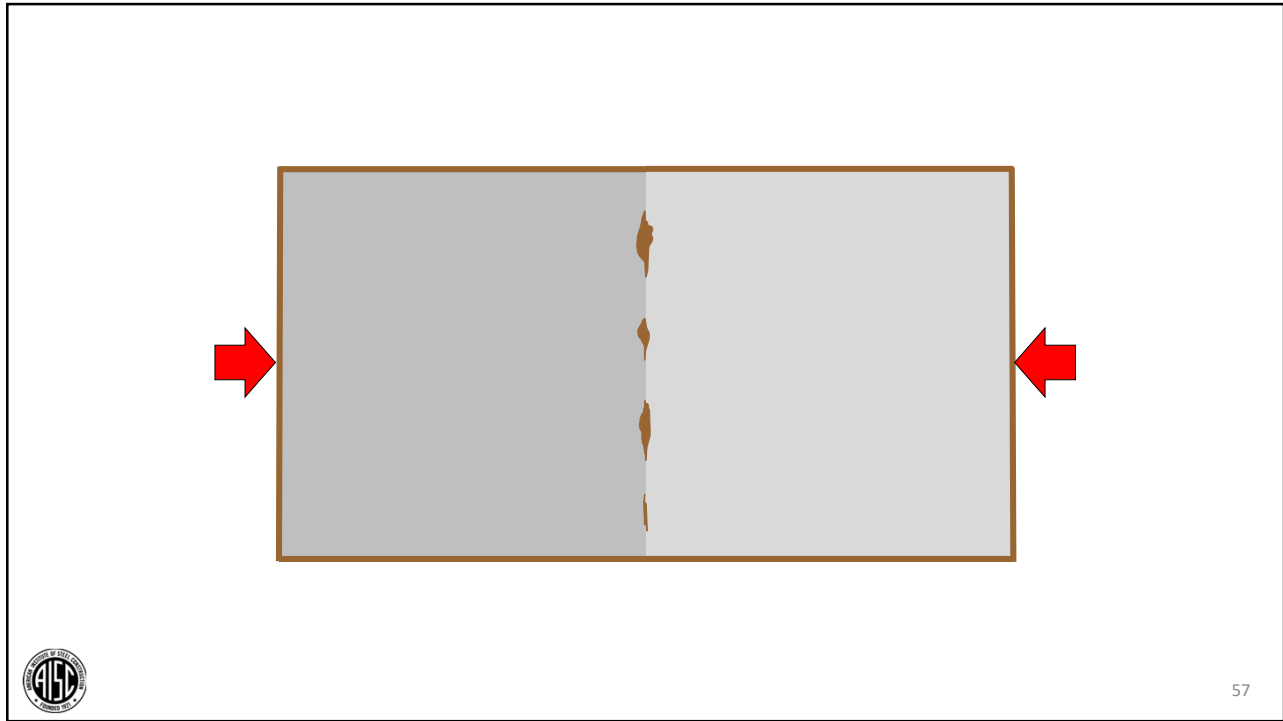

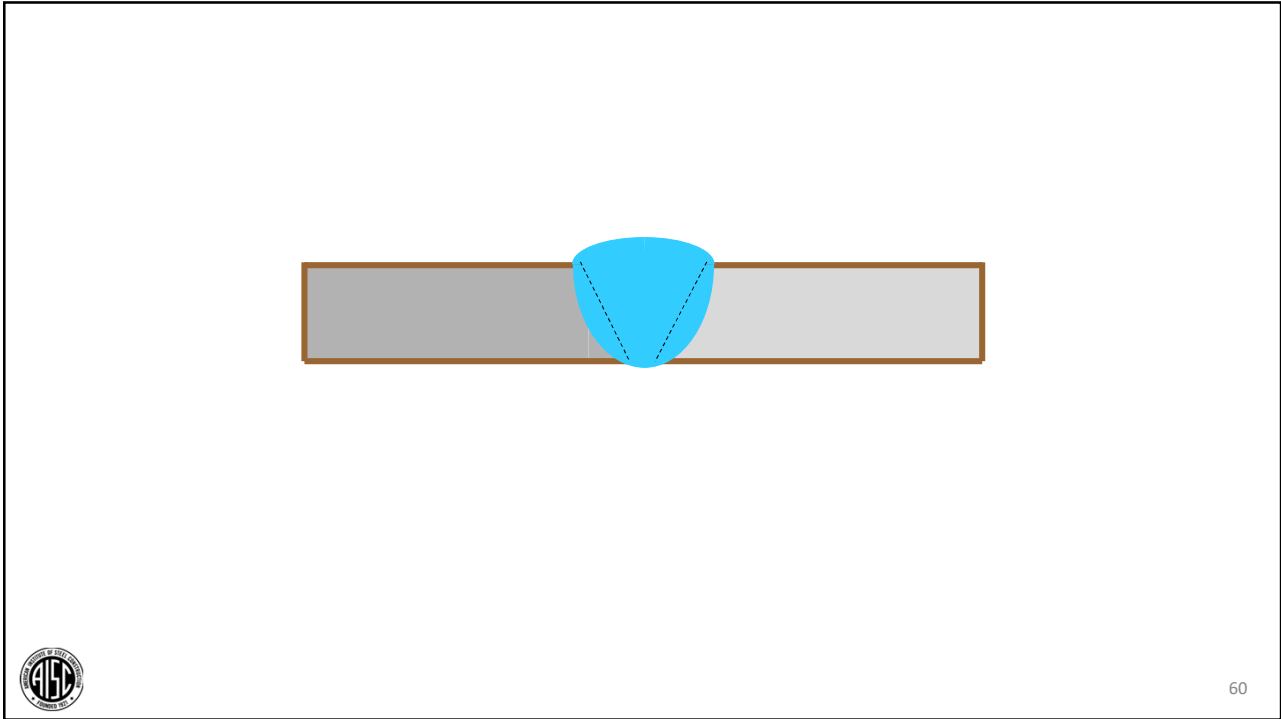
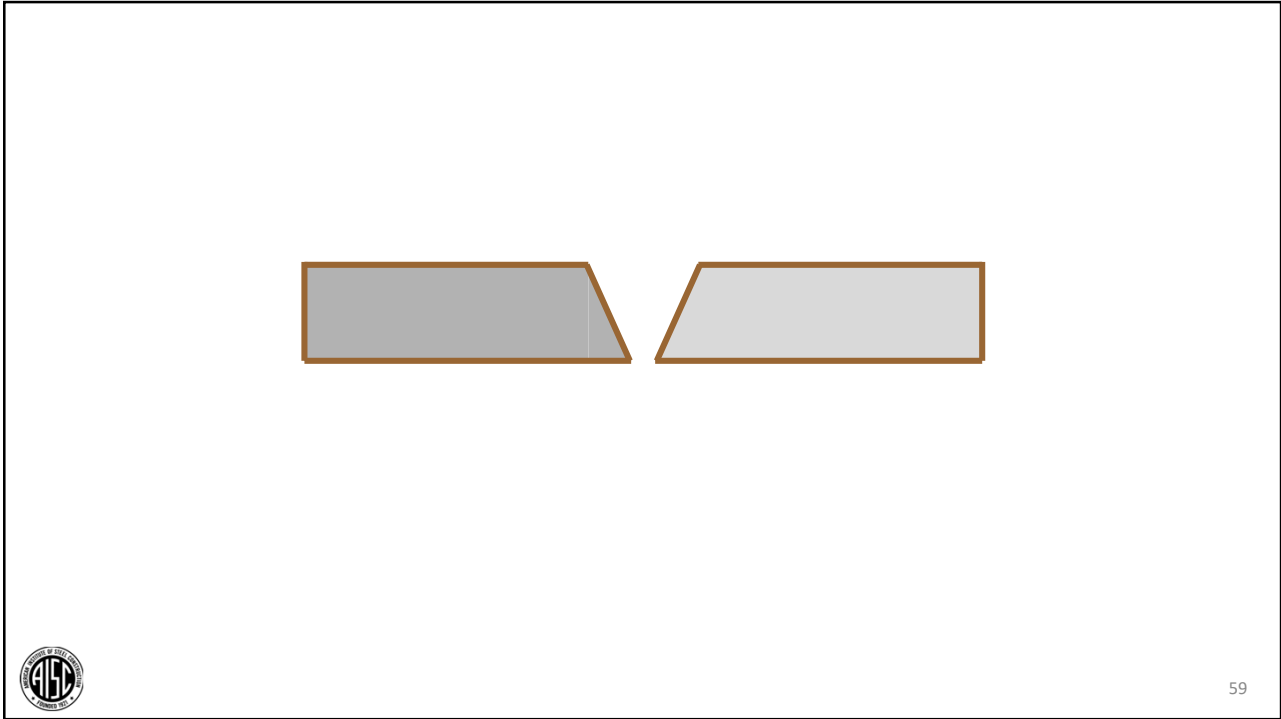

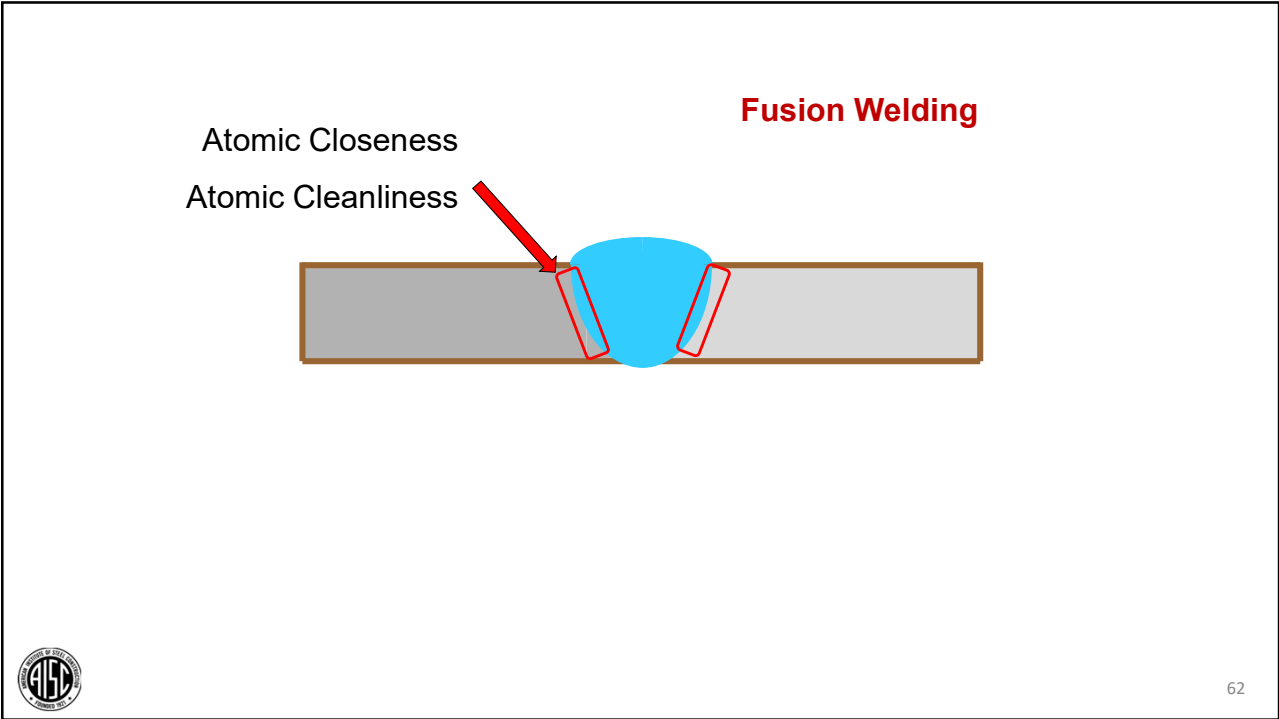
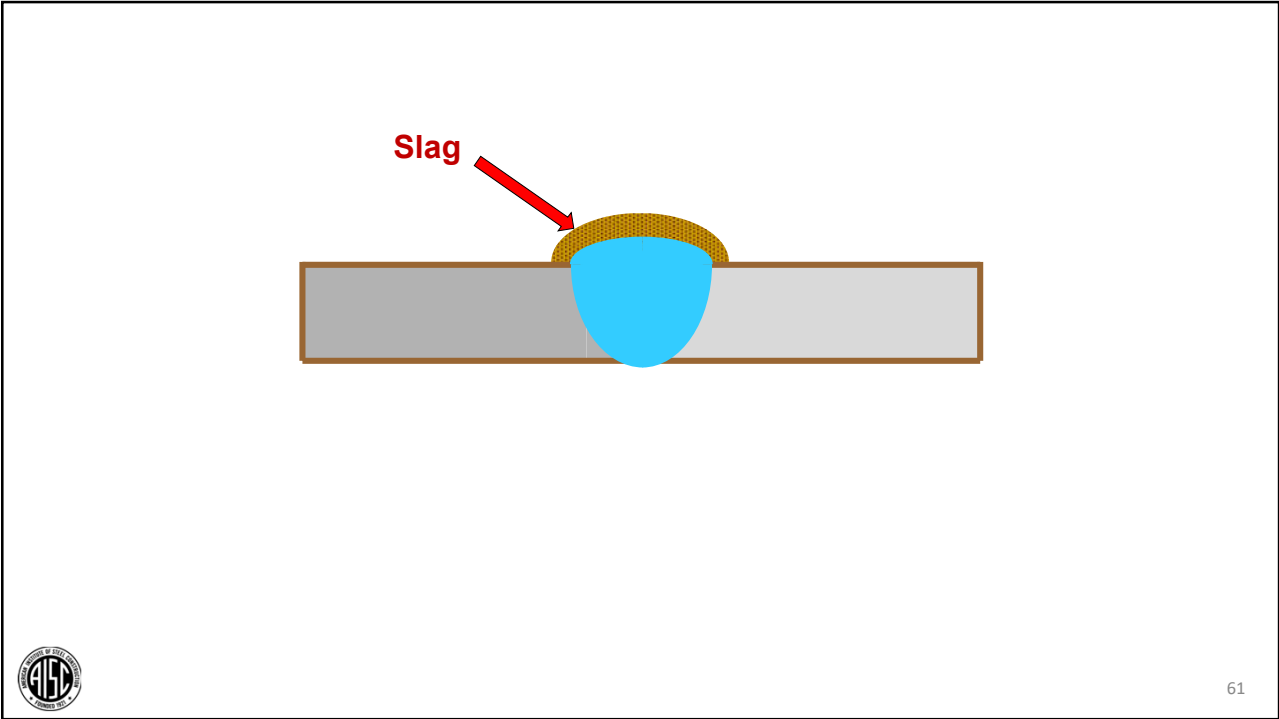



**AWS STANDARD WELDING TERMS & DEFINITIONS (A3.0:2020)**



**fusion, *fusion welding.***

The melting together of filler metal and base metal, or of base metal only, to produce a weld.



63

**AWS STANDARD WELDING TERMS & DEFINITIONS (A3.0:2020)**



**arc welding.**

A group of welding processes producing coalescence of workpieces by melting them with an arc. The processes are used with or without the application of pressure and with or without filler metal.



64

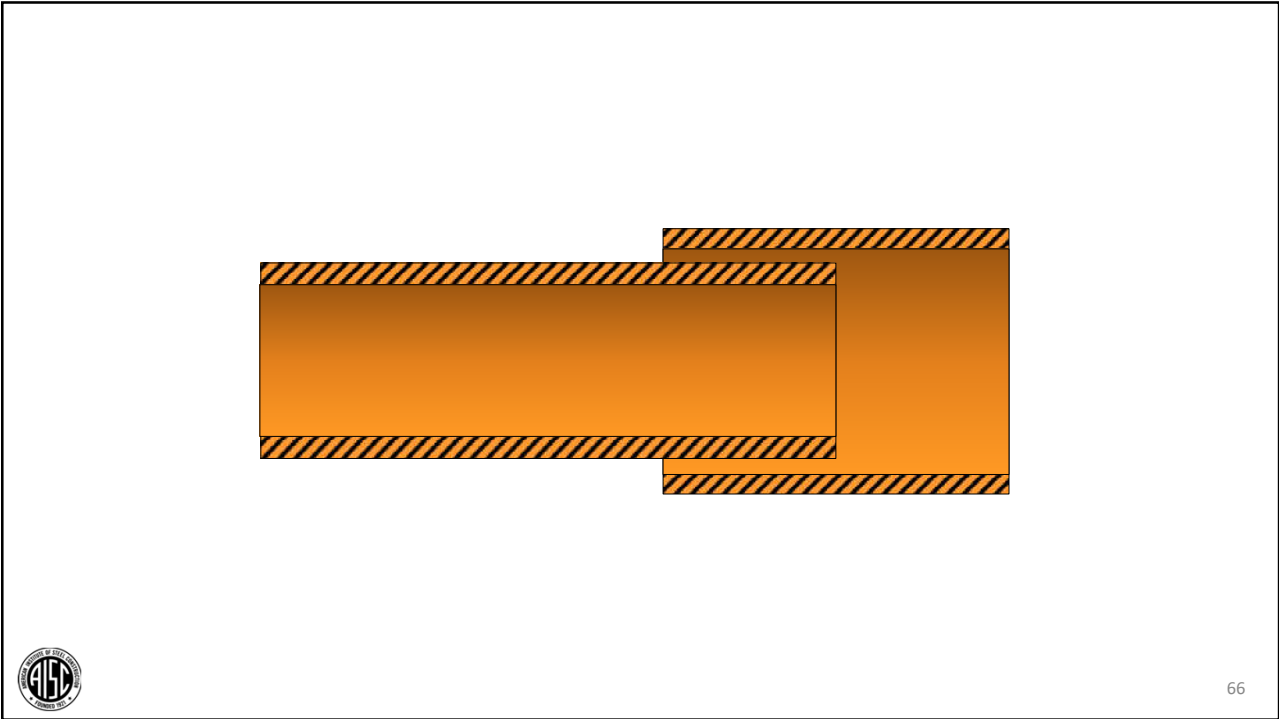
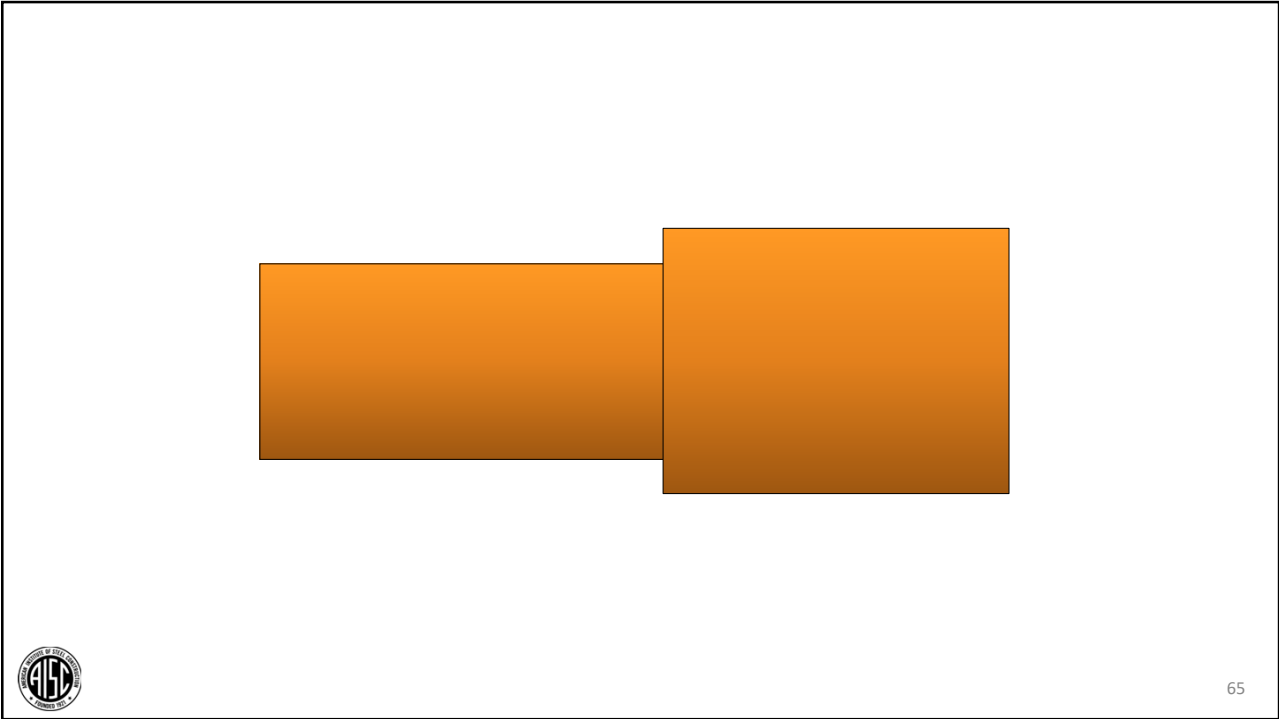

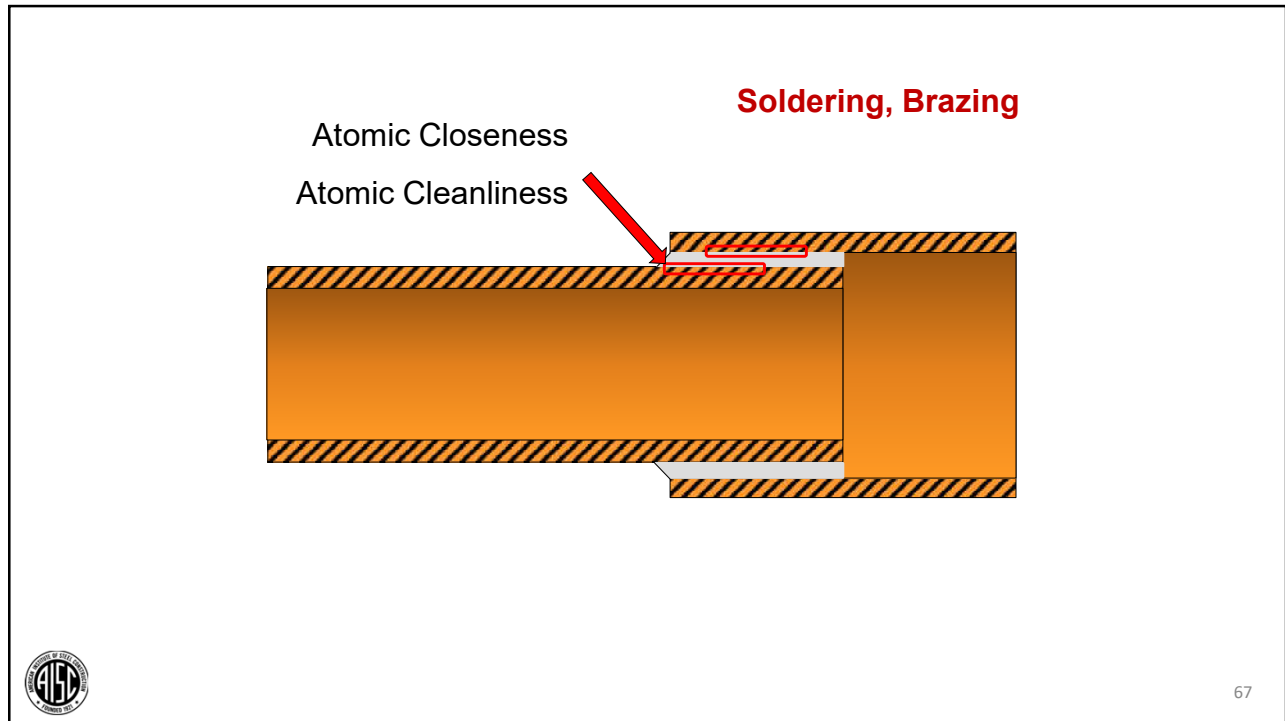

**AWS STANDARD WELDING TERMS & DEFINITIONS (A3.0:2020)**



**Soldering Filler Metal**

A filler metal having a liquidus below 450°C [840°F] to be added in making a soldered joint.



68

**AWS STANDARD WELDING TERMS & DEFINITIONS (A3.0:2020)**



**Brazing Filler Metal**

The filler metal to be added in making a brazed joint. The filler metal has a liquidus above 450°C [840°F] and below the solidus of the base material.

69



**Arc Welding Processes**



**How to protect the metal puddle from the atmosphere:**

- Inert gasses that displace the atmosphere
- Slags that form a mechanical barrier
- Both slags and gasses

70



## Arc Welding Processes



**Once a puddle is formed...**

**...the puddle must be protected from the atmosphere.**

- 80% Nitrogen
- 19% Oxygen

(Also, need to protect the metal droplets in the arc)



71

## Arc Welding Processes



**Once a puddle is formed...**

**...need to control the shape of the puddle.**

- Shielding gasses affect weld puddle surface tension (and the wetting of the puddle to the base metal)
- Slags can be used to support and shape weld puddles



72

## Arc Welding Processes



### Major arc welding processes:

- Shielded Metal Arc Welding (SMAW)
- Flux Core Arc Welding (FCAW)
- Gas Metal Arc Welding (GMAW)
- Submerged Arc Welding (SAW)
- Gas Tungsten Arc Welding (GTAW)
- Electroslag Welding (ESW)
- Electrogas Welding (EGW)
- Arc Stud Welding (ASW)



73

## Arc Welding Processes



### Major thermal cutting processes:

- Oxy-fuel Cutting (OFC)
- Plasma Arc Cutting (PAC)
- Air Arc Gouging (AAG)



74

## WELDED CONNECTION BASICS

### Outline

- Applicable Codes
- Arc Welding Processes – Overview
- ➔ • Welding and Thermal Cutting Processes
- Joints and Weld Types



75

## AWS STANDARD WELDING TERMS & DEFINITIONS (A3.0:2020)



### **shielded metal arc welding (SMAW).**

An arc welding process with an arc between a covered electrode and the weld pool. The process is used with shielding from the decomposition of the electrode covering, without the application of pressure, and with filler metal from the electrode.



76

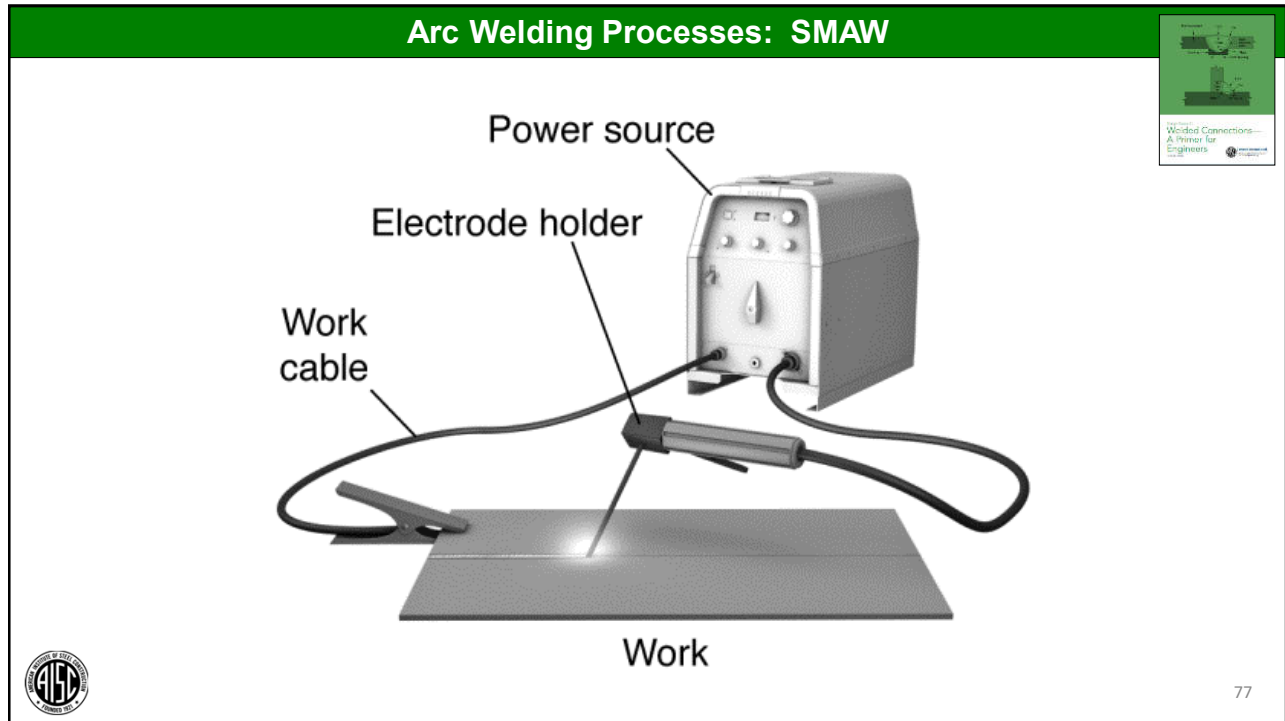

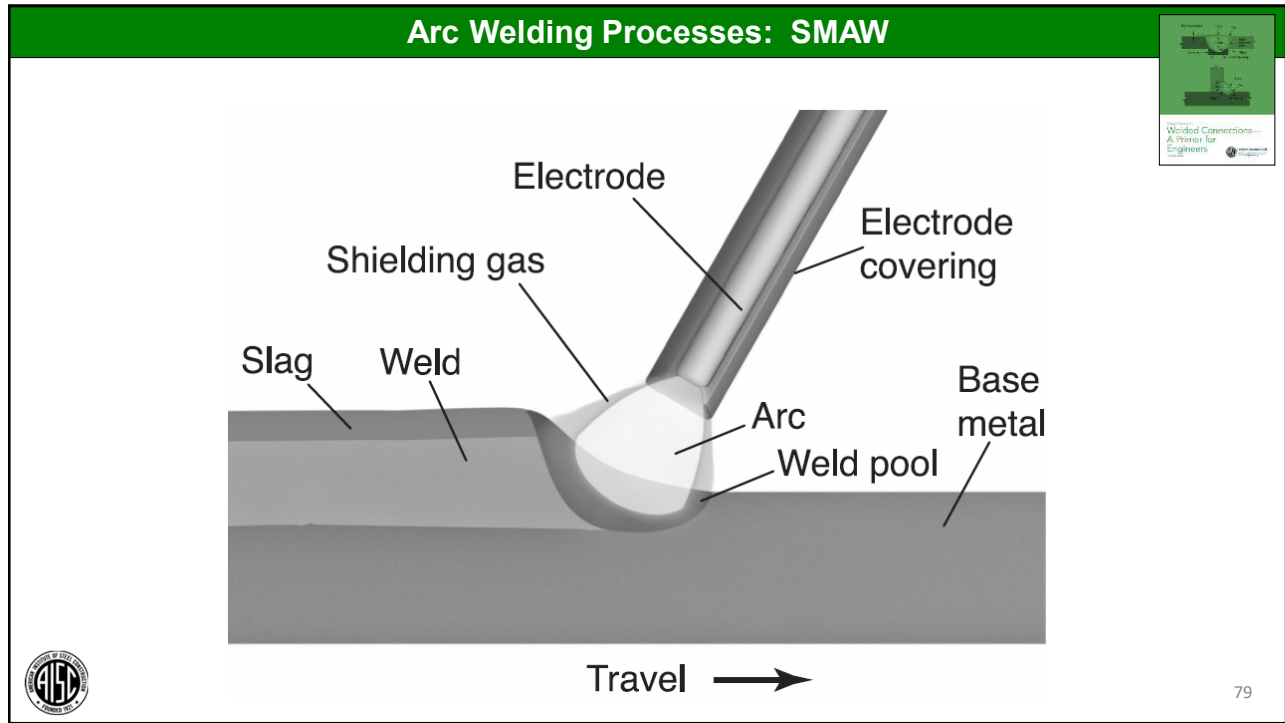

## Arc Welding Processes: SMAW

### Advantages:

- Simplicity
- Flexibility
- Familiarity



81



## Arc Welding Processes: SMAW

### Limitations:

- Variable resistor
- Electrodes are of finite length
- Stub loss
- Operator skill required



82



**ANSI Z49.1**

**Safety in Welding, Cutting, and Allied Processes**

Available by free download from AWS

**aws.org**

**www.aws.org/technical/facts**

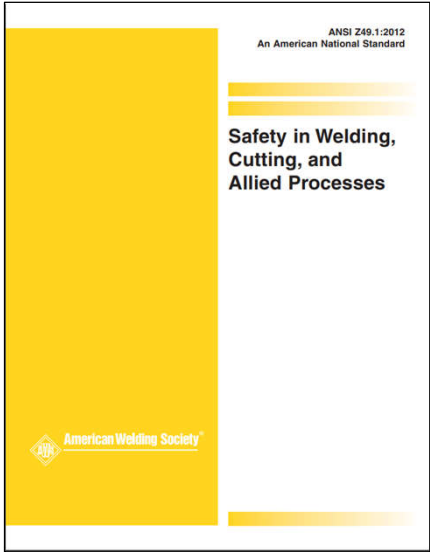

83



**The big four:**

- Arc
- Fire
- Electrical
- Fume

Not comprehensive.  
See Z49.1 for a complete listing

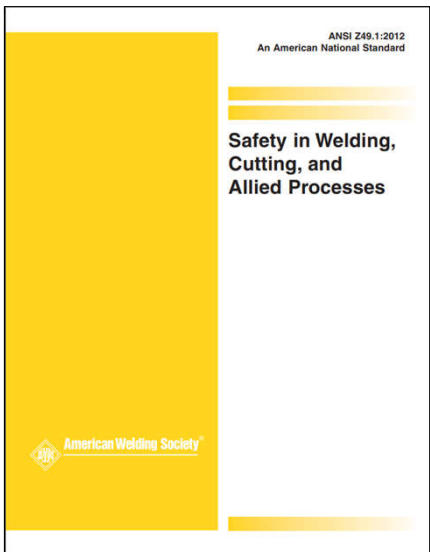

84



**AWS A5.1**

Specification for Carbon Steel Electrodes  
for Shielded Metal Arc Welding

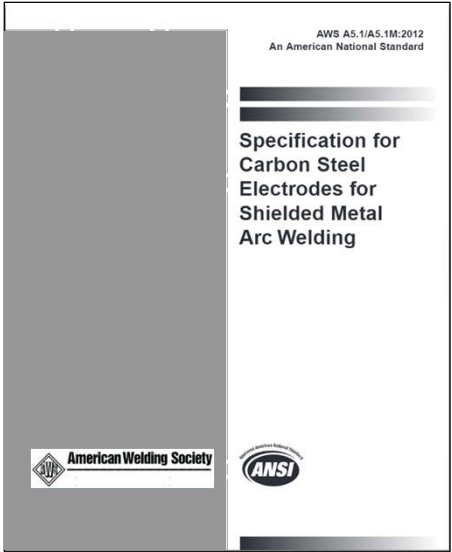

85



**AWS 5 Filler Metal Specifications**



**E7018**

**E**lectrode \_\_\_\_\_

**70** ksi minimum specified tensile strength \_\_\_\_\_

**1** = Position of welding \_\_\_\_\_

**8** = Coating type, mechanical properties \_\_\_\_\_

86



### AWS 5 Filler Metal Specifications



**E4918**

**E**lectrode \_\_\_\_\_

**490** MPa min. specified tensile strength \_\_\_\_\_

**1** = Position of welding \_\_\_\_\_

**8** = Coating type, mechanical properties \_\_\_\_\_



87

### AWS STANDARD WELDING TERMS & DEFINITIONS (A3.0:2020)



**flux cored arc welding (FCAW).**

An arc welding process using an arc between a continuous filler metal electrode and the weld pool. The process is used with shielding from a flux contained within the tubular electrode, with or without additional shielding gas, and without the application of pressure.



88

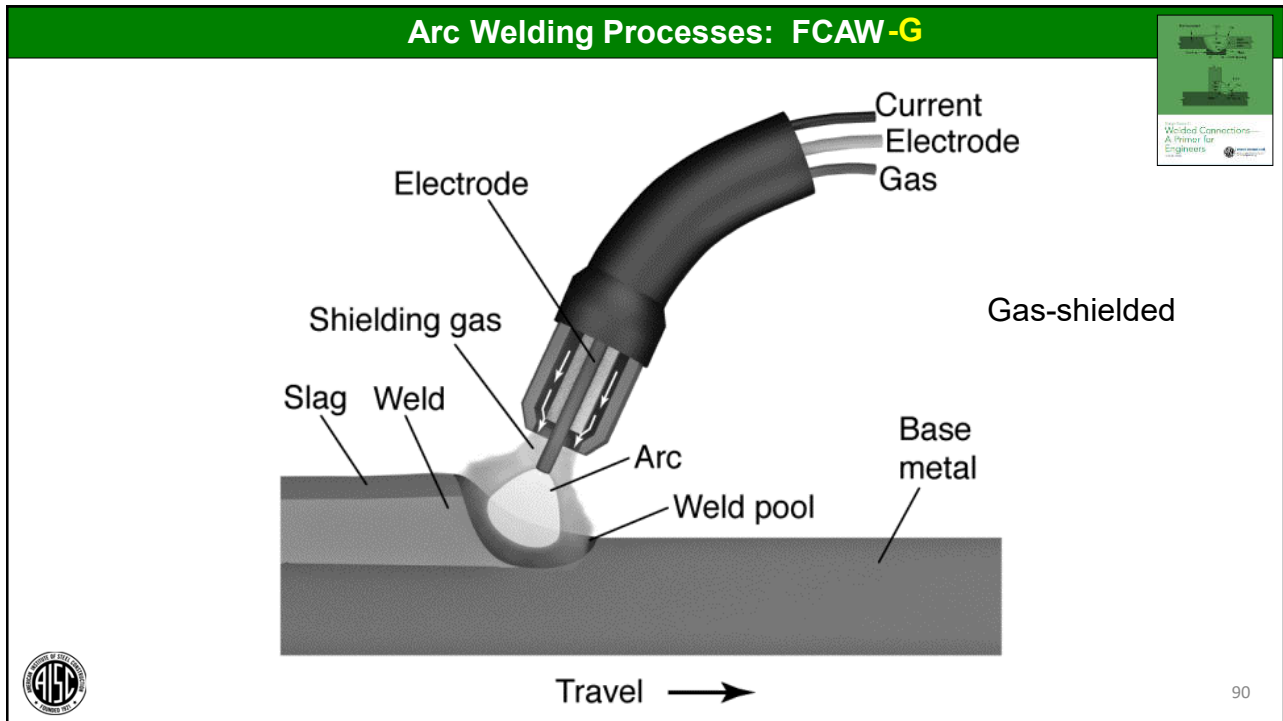
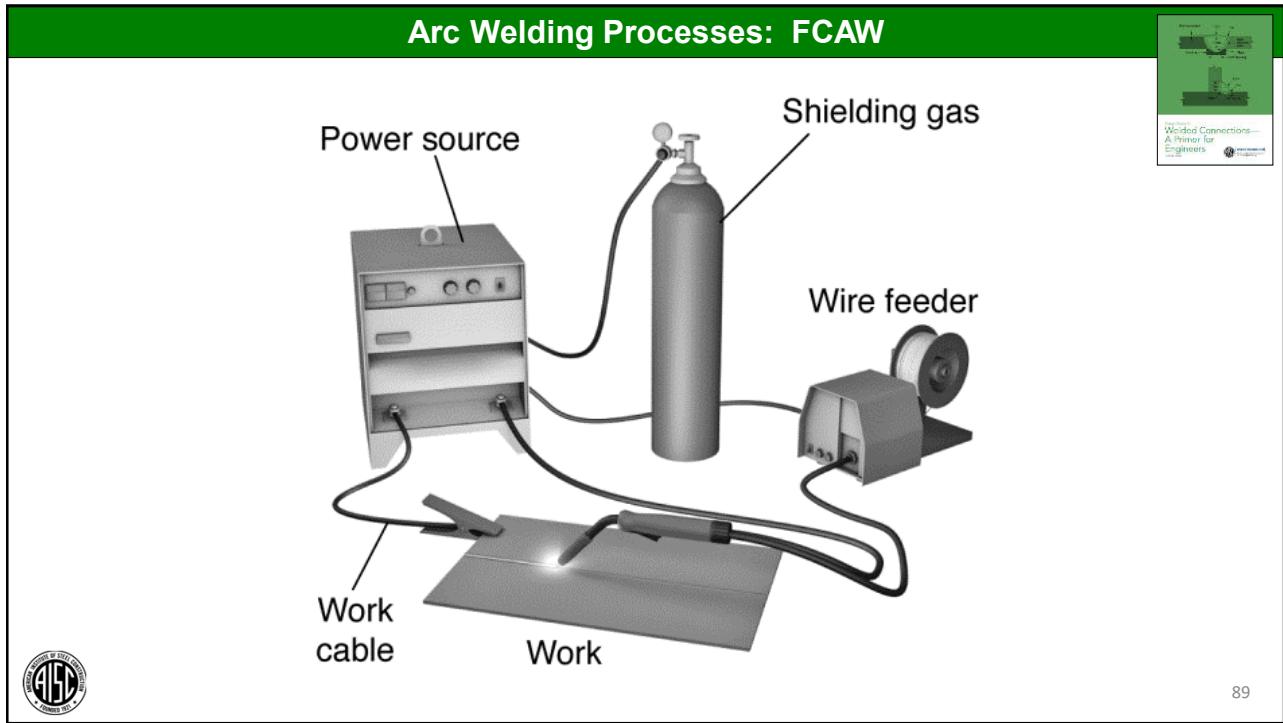



91

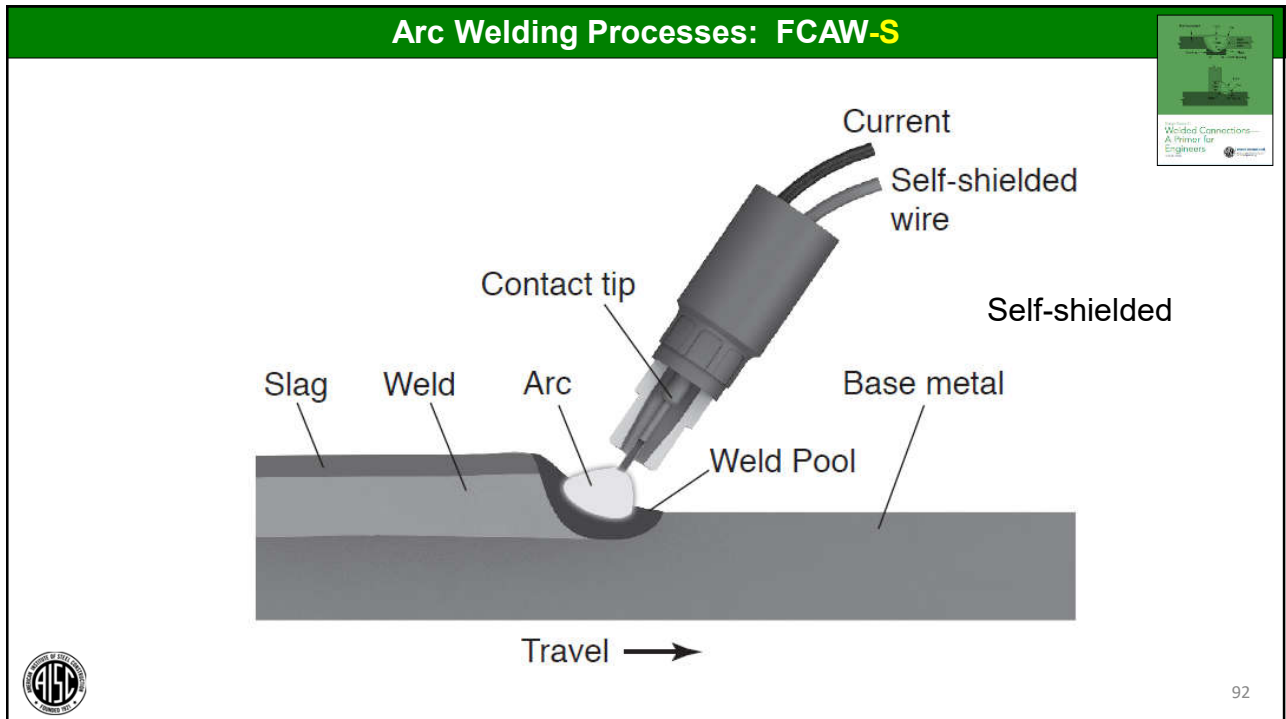

92



93

### Arc Welding Processes: FCAW



#### Advantages:

- Electrode is continuous
  - Eliminates built-in starts and stops
    - Economic advantage
    - Starts and stops are potential sources of weld discontinuities
- Increased amperages (over SMAW)
  - Increased deposition rate and productivity
- Fixed resistance for a given electrode extension
  - More uniform welding conditions are maintained



94

## Arc Welding Processes: FCAW



### Advantages:

- Process is semiautomatic
  - Welders maintains the electrode extension (i.e., stickout distance) but do not need to maintain an arc length, nor do they feed the filler metal into the joint
- Process can also be mechanized or automatic



95

## Arc Welding Processes: FCAW



### Limitations:

- Welding equipment costs more and is less portable than for SMAW
- Changes are more complicated than for SMAW



96

## Arc Welding Processes: FCAW-G



### Advantages:

- More versatile than self-shielded flux-cored electrodes
- Provide better arc action
- High operator appeal
- Shielding from wind is not difficult in enclosed shop fabrication situations
- Weld appearance and quality are very good
- Higher-strength gas-shielded FCAW electrodes are available than for FCAW-S



97

## Arc Welding Processes: FCAW-G



### Limitations:

- The need to protect the gas shield
  - AWS D1.1 limits the maximum wind velocity to 5 mph [8 km/h]
- When welding under windy conditions, porosity is likely
- Studies have shown that at wind speeds less than 5 mph, and before onset of porosity, ductility and toughness may decrease
  - AWS D1.8 has limited maximum wind velocity to 3 mph [5 km/h]



98

## Arc Welding Processes: FCAW-S



### Advantages:

- Ideal when wind may disturb the gas shield (e.g., field conditions or relatively open fabrication shops)
  - Welds have been made up to 10 mph [16 km/h] without harmful effects
- No need for gas cylinders, hoses and regulators
- No concerns about gas nozzles being plugged with weld spatter
- Gun and cable assembly is simpler than for gas-shielded
  - More suitable for welding in restricted spaces



99

## Arc Welding Processes: FCAW-S



### Limitations:

- Technology is limited to 90 ksi [620 MPa] tensile strength or less
- Arc action not as good as FCAW-G



100

**AWS STANDARD WELDING TERMS & DEFINITIONS (A3.0:2020)**



**gas metal arc welding (GMAW).**

An arc welding process using an arc between a continuous filler metal electrode and the weld pool. The process is used with shielding from an externally supplied gas and without the application of pressure.

**Note:** may use solid electrode, or metal cored electrode.



**Arc Welding Processes: GMAW**

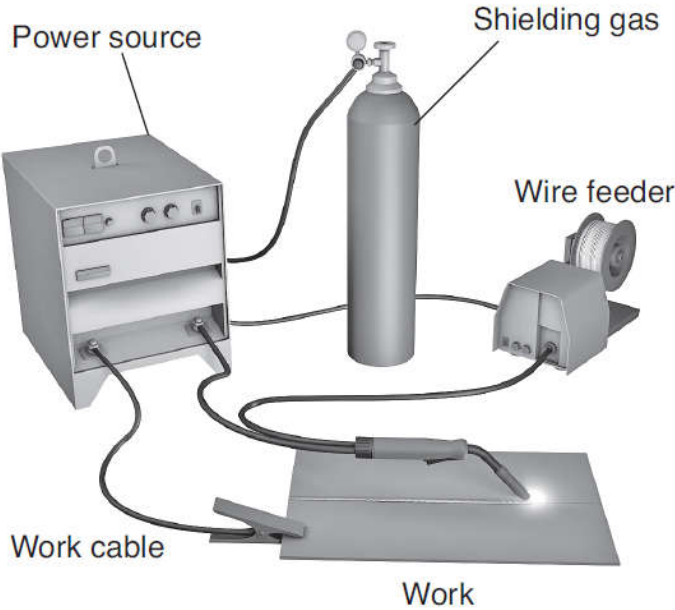

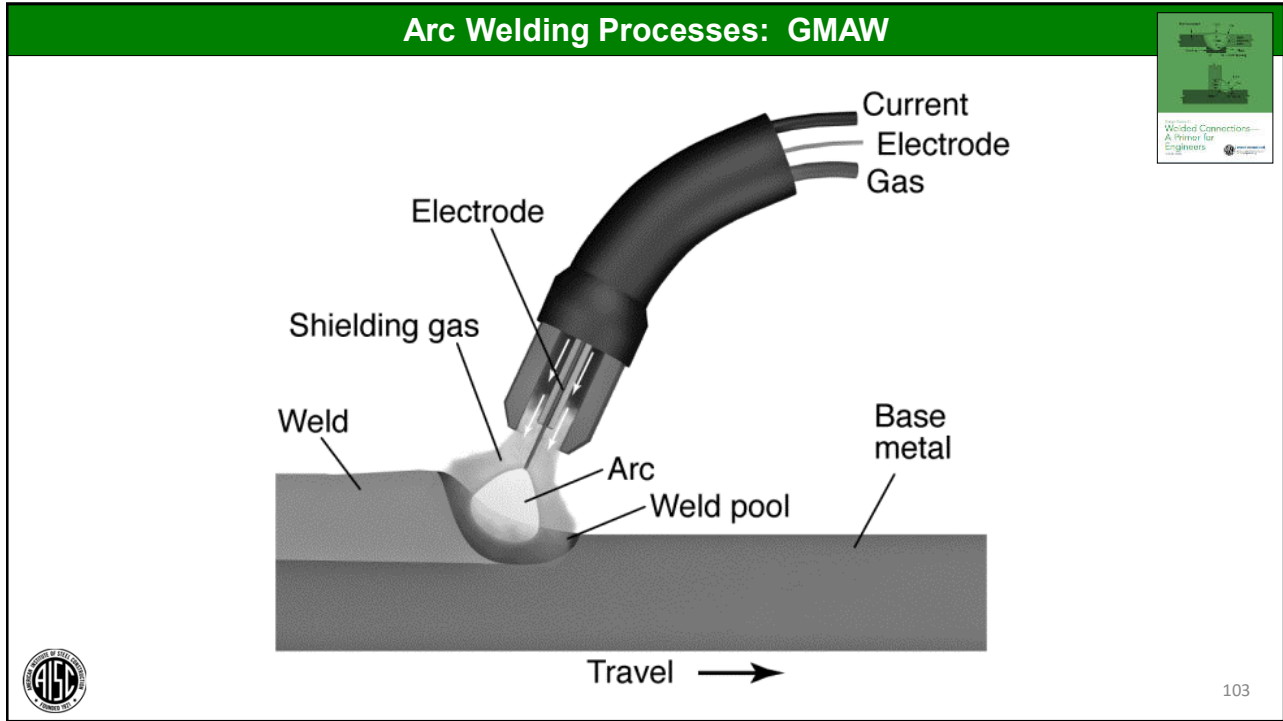

## Arc Welding Processes: GMAW

### GMAW Modes of Metal Transfer

- Spray
- Globular
- Short-Circuiting (shortarc)
- Pulsed



105



## Arc Welding Processes: GMAW Spray

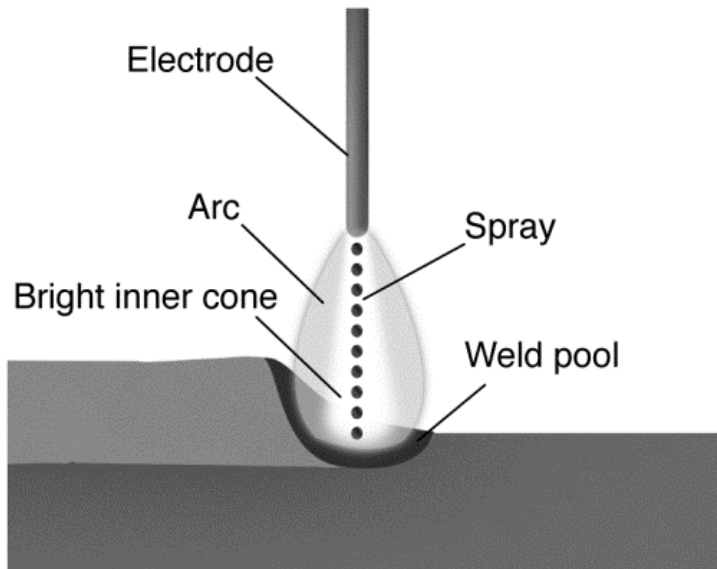

106



## Arc Welding Processes: GMAW



### Mode of Transfer-dependent Advantages and Limitations:

- Spray
  - Permits higher deposition rates and deposits welds with good appearance
  - Requires higher-cost, argon-based shielding gas mixtures, and can only be used in horizontal and flat positions



107

## Arc Welding Processes: GMAW Globular

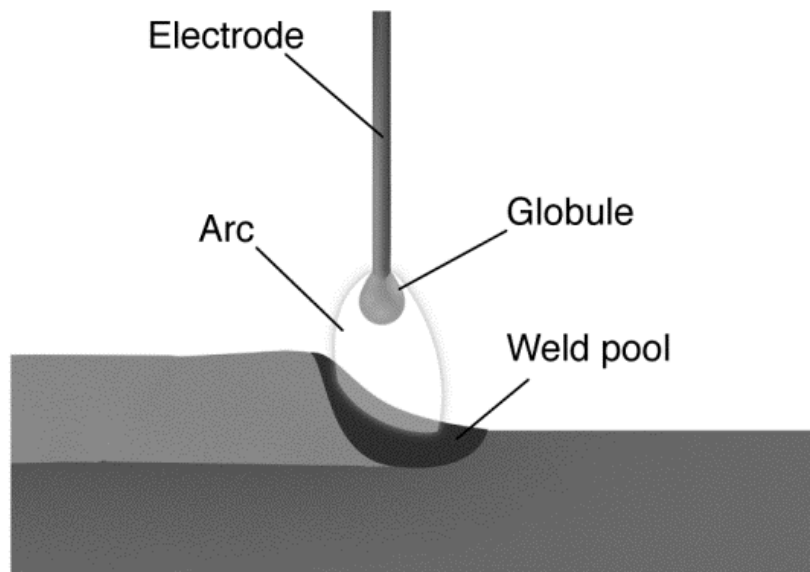

108

## Arc Welding Processes: GMAW



### Mode of Transfer-dependent Advantages and Limitations:

- Globular
  - Uses low-cost carbon dioxide shielding and offers high deposition rates
  - Weld appearance is inferior to spray transfer; excessive weld spatter is typical; restricted to horizontal and flat positions



109

## Arc Welding Processes: GMAW Short-Circuiting

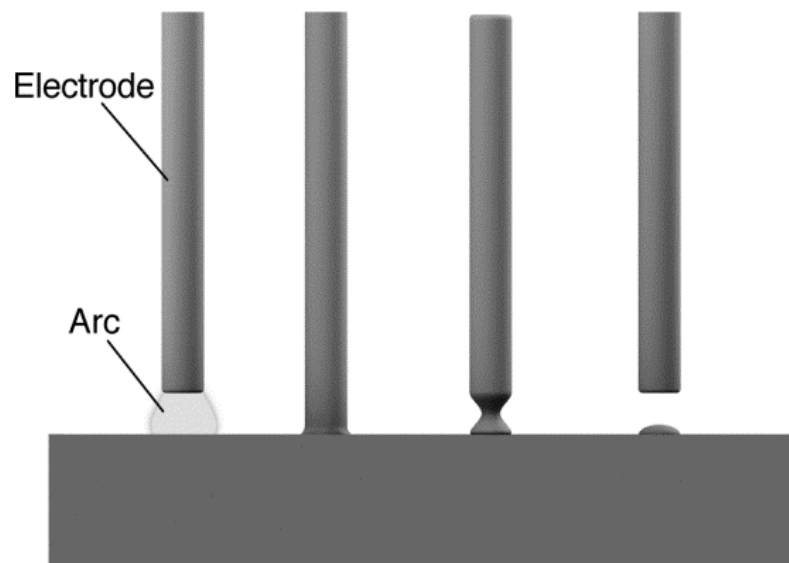

110

## Arc Welding Processes: GMAW



### Mode of Transfer-dependent Advantages and Limitations:

- Short-circuit
  - Ideal for sheet metal; can be used for vertical and overhead positions
  - Strong tendency for fusion-type defects (incomplete fusion) makes it undesirable for most structural applications
  - Not prequalified in AWS D1.1
  - Welders must be qualified with the short-circuit mode of transfer



111

## Arc Welding Processes: GMAW Pulsed

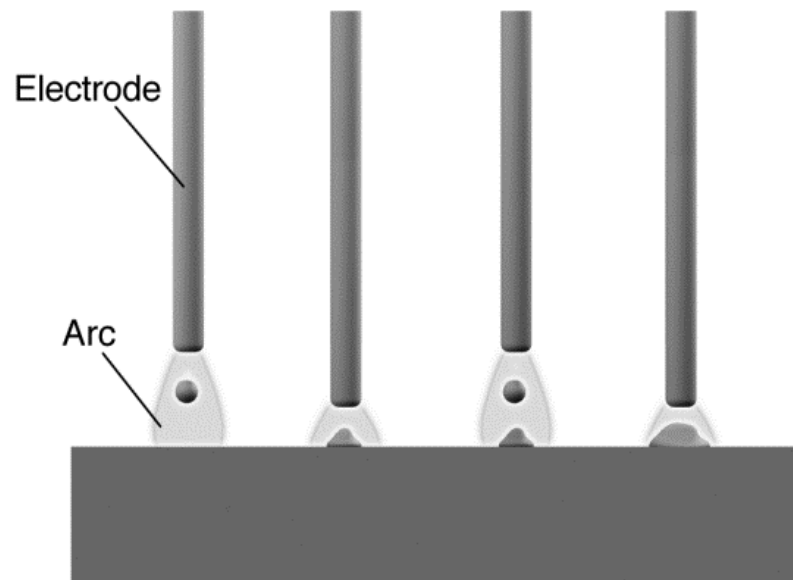

112

## Arc Welding Processes: GMAW



### Mode of Transfer-dependent Advantages and Limitations:

- Pulsed
  - Permits all-position welding; deposits weld with good appearance
  - Requires use of more expensive, argon-based shielding gas mixtures
  - Welding equipment is more expensive and complex



113

## Arc Welding Processes: GMAW



### Advantages:

- No slag covers the weld; cleanup is simple and low cost
- Electrodes cost less than flux-cored electrodes
- Deposits welds with low levels of diffusible hydrogen
  - Significant advantage for welding on high strength steels
- Carries advantages of automatic and semiautomatic processes
  - Many robotic welding applications use GMAW, due to freedom from slag cleanup
  - Multiple-pass welding is easily accomplished



114

## Arc Welding Processes: GMAW



### Limitations:

- Process is more sensitive to contaminants on the steel surface (such as mill scale, rust, and oil)
  - May result in porosity
  - Heavy scale may inhibit fusion
- Limited similar to FCAW-G
  - If gas shield is disturbed, porosity will result
  - Even before onset of porosity, ductility and toughness may deteriorate



115

## AWS STANDARD WELDING TERMS & DEFINITIONS (A3.0:2010)



### submerged arc welding (SAW).

An arc welding process using an arc or arcs between a bare metal electrode and the weld pool. The arc and molten metal are shielded by a blanket of granular flux on the workpieces. The process is used without pressure and with filler metal from the electrodes and sometimes from a supplemental source (welding rod, flux, or metal granules).



116

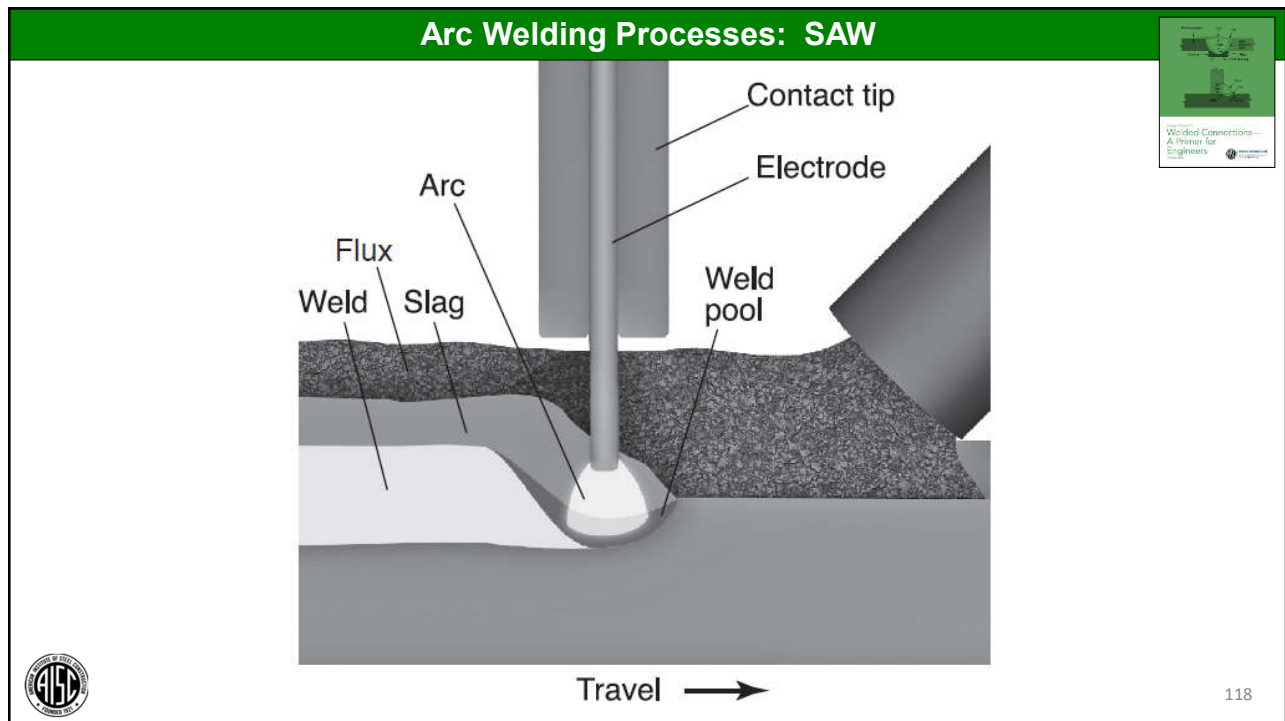
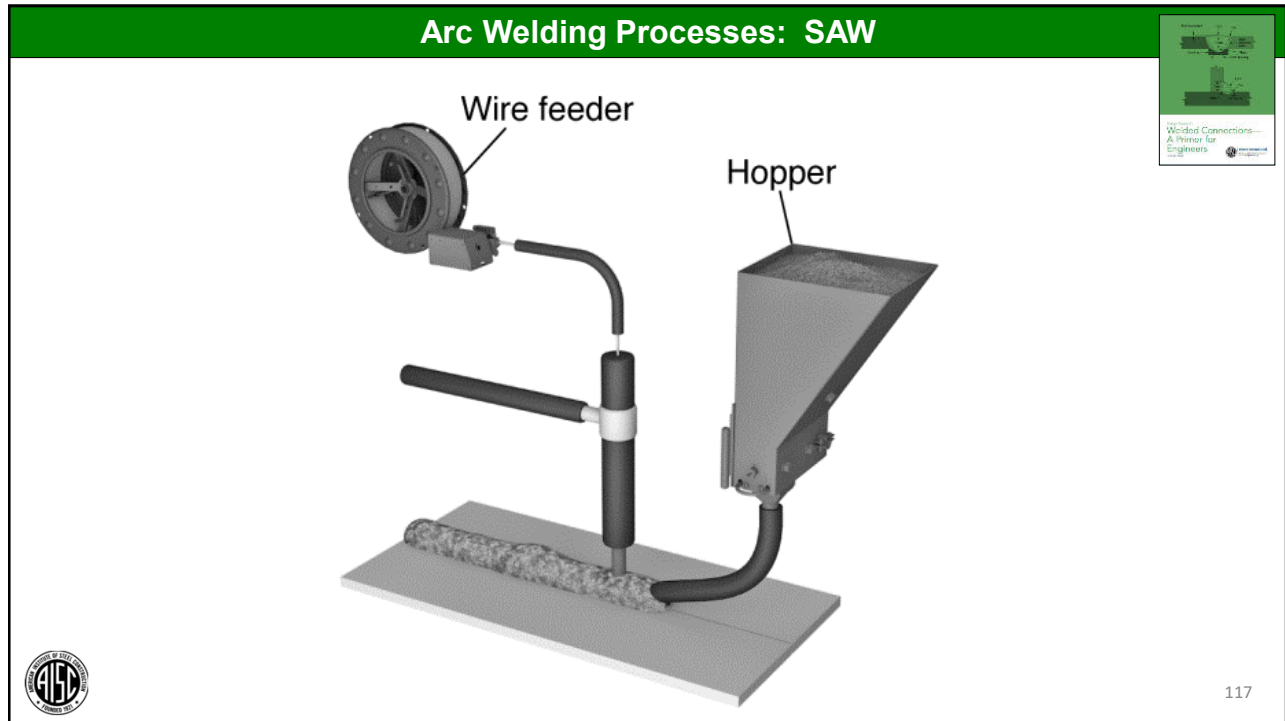



119



120



## Arc Welding Processes: SAW



### Advantages:

- Uses higher welding currents, leading to higher productivity and deeper penetration
  - Deeper penetration may allow fillet weld sizes to be reduced or may permit the use of groove weld details that require less weld metal
- Square wave technology may further increase deposition rate without increasing current
- For higher deposition rates, a second or third electrode can be added into the system to further increase productivity
- Process is typically mechanized or automatic
  - Welds are usually continuous for length of the joint



123

## Arc Welding Processes: SAW



### Advantages:

- Welds made under protective layer of flux are excellent in appearance and spatter-free
  - Particularly significant for architecturally exposed structural steel (AESS)
- Freedom from the open arc
  - Welder does not need to use the standard protective helmet
  - Operations can be done in tight, restricted areas
  - Produces little smoke, therefore can be used in situations with restricted ventilation



124

## Arc Welding Processes: SAW



### Limitations:

- Freedom from open arc does not allow the operator to observe the weld puddle
  - When done semiautomatically, operator must learn to propel gun carefully to ensure uniform bead contour
  - Degree of skill is significant for multiple-pass welds
- Better for long, uninterrupted seams rather than short, intermittent welds
- Restricted to flat and horizontal position



125

## AWS STANDARD WELDING TERMS & DEFINITIONS (A3.0:2020)



### gas tungsten arc welding (GTAW).

An arc welding process using an arc between a tungsten electrode (nonconsumable) and the weld pool. The process is used with shielding gas and without the application of pressure.



126

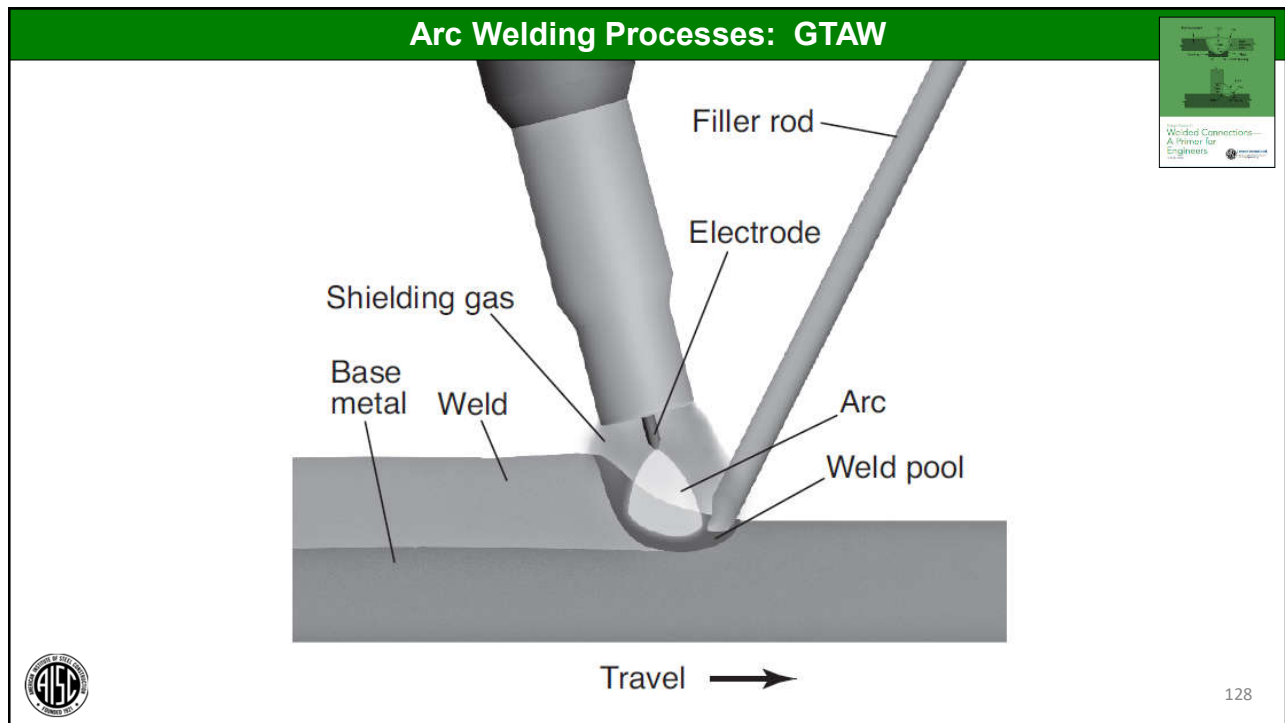
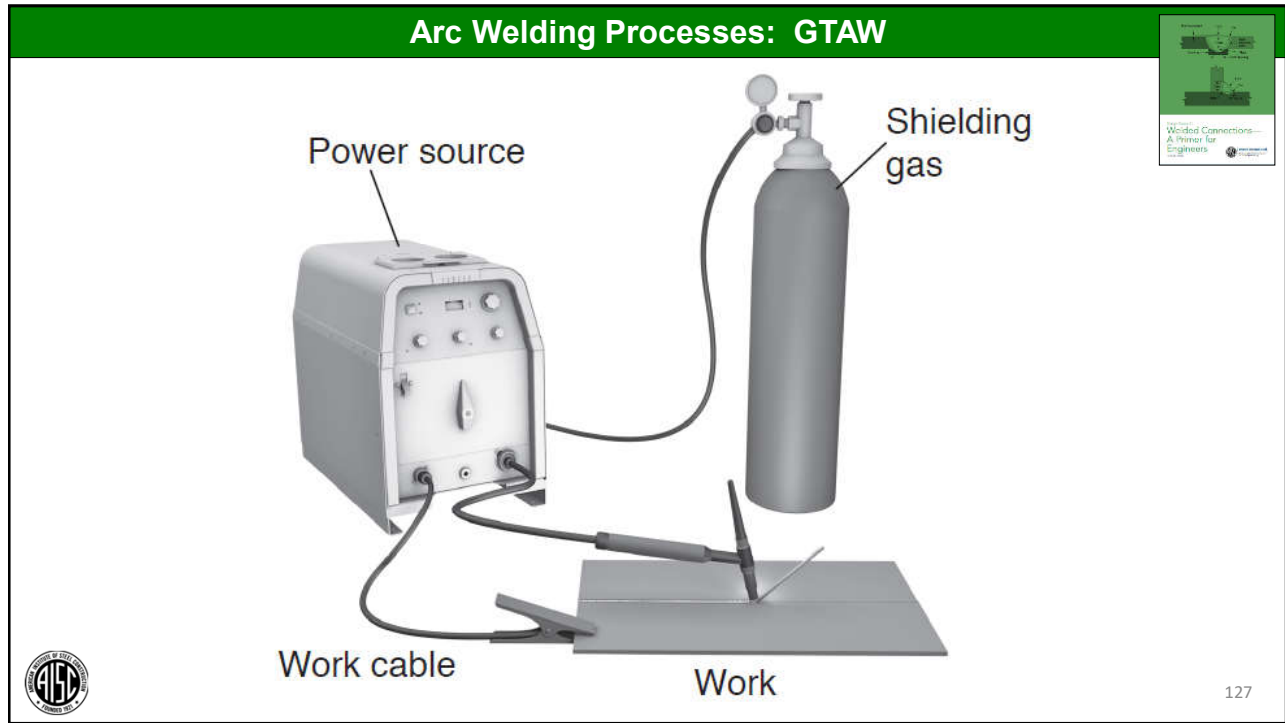



## AWS STANDARD WELDING TERMS & DEFINITIONS (A3.0:2010)



### **electroslag welding (ESW).**

A welding process producing coalescence of metals with molten slag, melting the filler metal and the surfaces of the workpieces. The weld pool is shielded by this slag, which moves along the full cross section of the joint as welding progresses. The process is initiated by an arc that heats the slag. The arc is then extinguished by the conductive slag, which is kept molten by its resistance to electric current passing between the electrode and the workpieces.



131

## AWS STANDARD WELDING TERMS & DEFINITIONS (A3.0:2010)



### **electrogas welding (EGW).**

An arc welding process using an arc between a continuous filler metal electrode and the weld pool, employing approximately vertical welding progression with backing to confine the molten weld metal. The process is used with or without an externally supplied shielding gas and without the application of pressure.



132

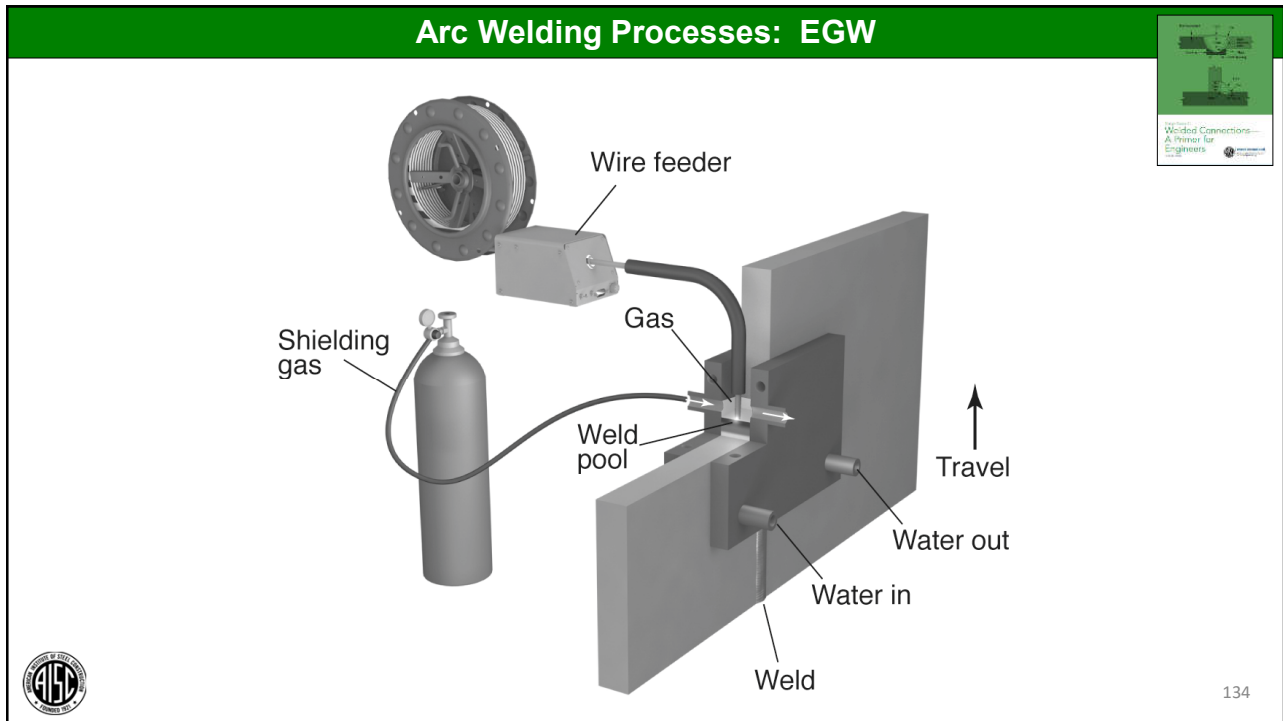
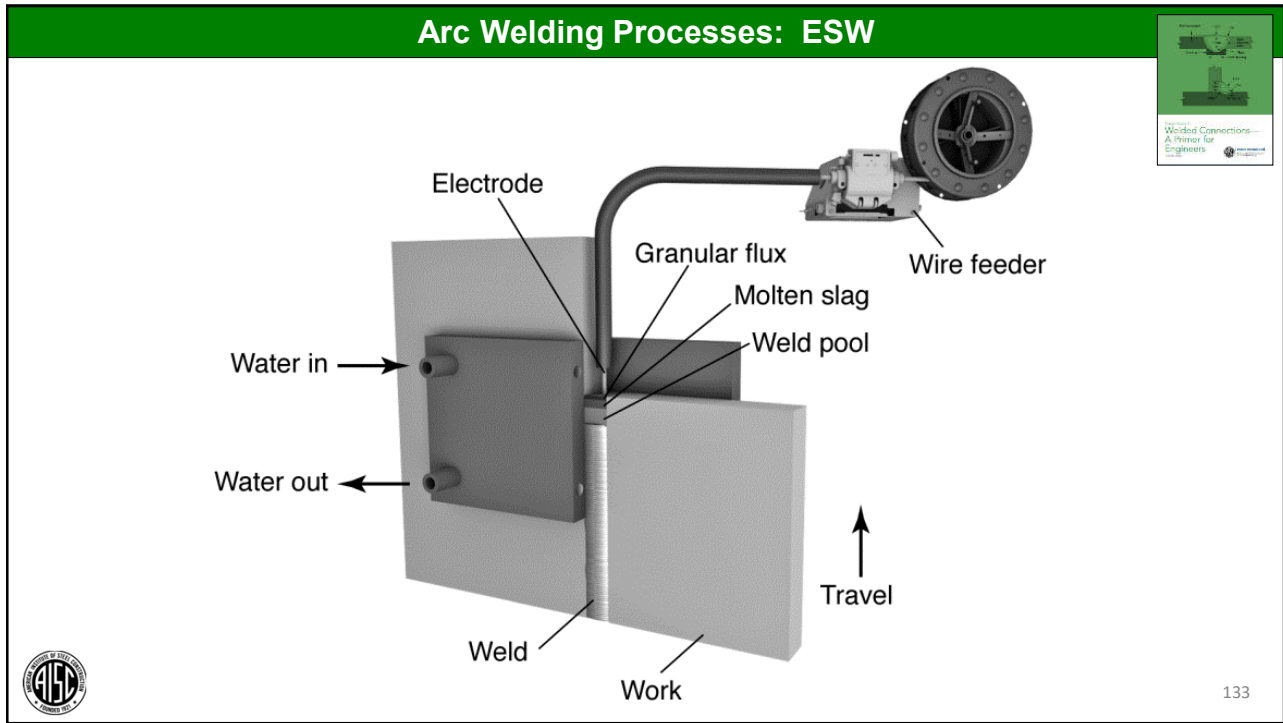

**Arc Welding Processes: ESW / EGW**

**Applications**

- “Blind welds” on box column stiffeners



135

**Arc Welding Processes: ESW / EGW**

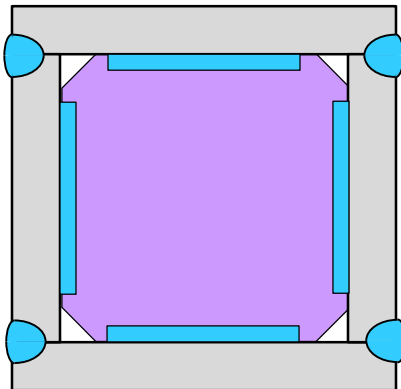

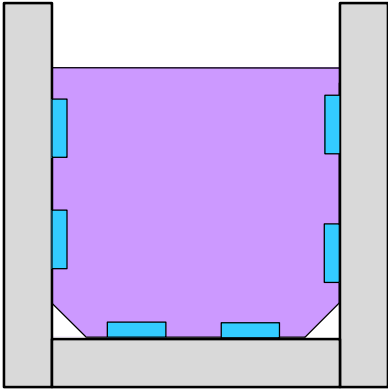

136

### Arc Welding Processes: ESW / EGW



The diagram shows a cross-section of a groove joint between two vertical steel plates. The groove is filled with a purple molten metal pool. Two light blue electrodes are positioned on the left and right sides of the pool, with their tips submerged. At the bottom of the groove, two light blue weld ripples are visible, indicating the start of the welding process.



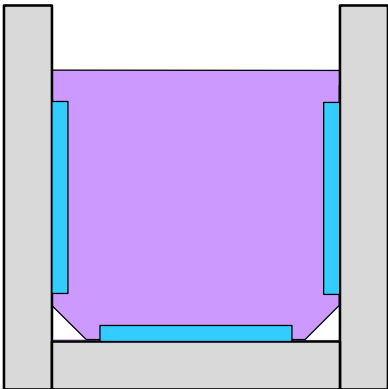

137

### Arc Welding Processes: ESW / EGW





The diagram shows a cross-section of a groove joint between two vertical steel plates. The groove is filled with a purple molten metal pool. Two light blue electrodes are positioned on the left and right sides of the pool, with their tips submerged. A single light blue weld ripple is visible at the bottom center of the groove, indicating the end of the welding process.



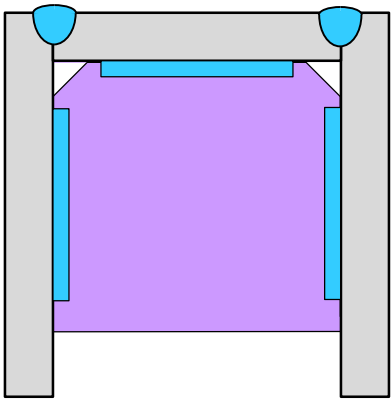

138

### Arc Welding Processes: ESW / EGW



139

### Arc Welding Processes: ESW / EGW

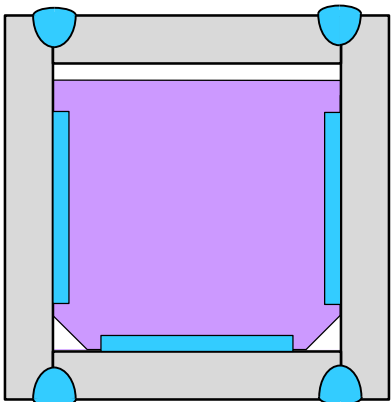

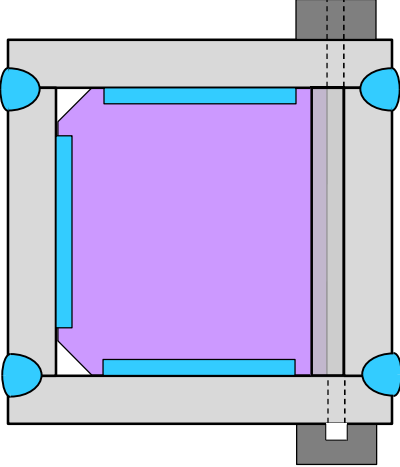

140

### Arc Welding Processes: ESW / EGW



The diagram shows a square column section with a purple interior. A vertical weld line is shown on the right side of the column, extending from the top flange to the bottom flange. The weld is represented by a blue line with a hatched area on the left side, indicating the weld metal. The column is supported by a base plate at the bottom and a top flange at the top. The corners of the column are rounded and colored blue.



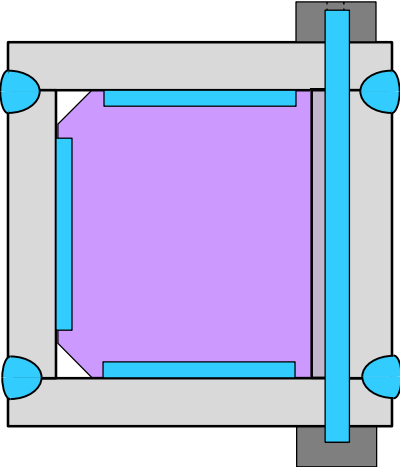

141

### Arc Welding Processes: ESW / EGW



The diagram shows a square column section with a purple interior. A vertical weld line is shown on the right side of the column, extending from the top flange to the bottom flange. Additionally, a horizontal weld line is shown on the top flange, extending across the width of the column. The welds are represented by blue lines with hatched areas. The column is supported by a base plate at the bottom and a top flange at the top. The corners of the column are rounded and colored blue.



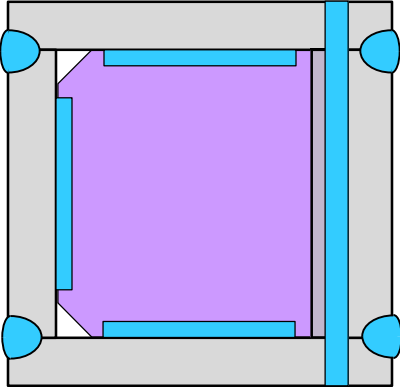

142

### Arc Welding Processes: ESW / EGW



The diagram shows a cross-section of a steel box column stiffener. A central purple rectangular stiffener is positioned within a larger grey rectangular box. The stiffener is connected to the box walls by blue welds. Specifically, there are vertical welds on the left and right sides of the stiffener, and horizontal welds at the top and bottom. The corners of the box are reinforced with blue circular elements, likely representing bolts or gusset plates. The welds are shown as solid blue lines, indicating a full penetration or similar strong connection.





143

### Arc Welding Processes: ESW / EGW

#### Applications

- “Blind welds” on box column stiffeners
- Flange splices for plate girders
- Miscellaneous applications (columns to base plates, flange plates to columns, continuity plates)



144

## Arc Welding Processes: ESW / EGW



### Advantages:

- Very high deposition rates
- Normally, joint details involve square edges, eliminating beveling costs
- Material handling might be reduced because plates do not need to be flipped as is the case for double-sided welds made with SAW, for example
- Angular distortion can be reduced
- Advantageous for cyclically loaded structures
  - Center of the vertical weld is last to solidify, putting the face of the weld in compression, enabling better resistance to cyclic tensile stresses



145

## Arc Welding Processes: ESW / EGW



### Advantages:

- Ability to weld in blind joints (e.g., diaphragm plates in box columns)
  - Can weld through a hole in the box
- Ideal for welding on thicker materials (1 in. [25 mm] or greater)



146

## Arc Welding Processes: ESW / EGW



### Limitations:

- Not well-suited for thinner materials
- Equipment and fixturing are more expensive and less flexible
- Sensitive process with many variables
  - Specific operator training is required
  - AWS D1.1 requires all ESW and EGW welding procedure specifications be qualified by test
  - Different variables: fit of copper shoes to the work, temperature of the shoes, thickness of the slag layer
- Large heat affected zone and potentially low fracture toughness of welds



147

## AWS STANDARD WELDING TERMS & DEFINITIONS (A3.0:2010)



### arc stud welding (SW).

An arc welding process using an arc between a metal stud, or similar part, and the other workpiece. The process is used without filler metal, with or without shielding gas or flux, with or without partial shielding from a ceramic or graphite ferrule surrounding the stud, and with the application of pressure after the faying surfaces are sufficiently heated.



148

### Arc Welding Processes: SW

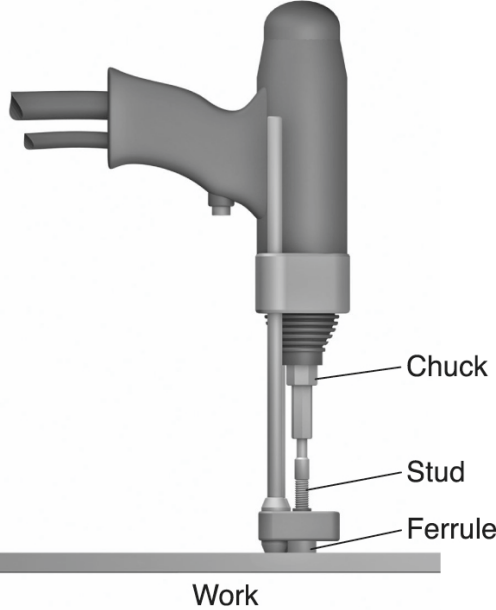

Chuck  
Stud  
Ferrule

Work



Welded Connections—  
A Primer for  
Engineers

149

### Thermal Cutting Processes: Oxyfuel Cutting

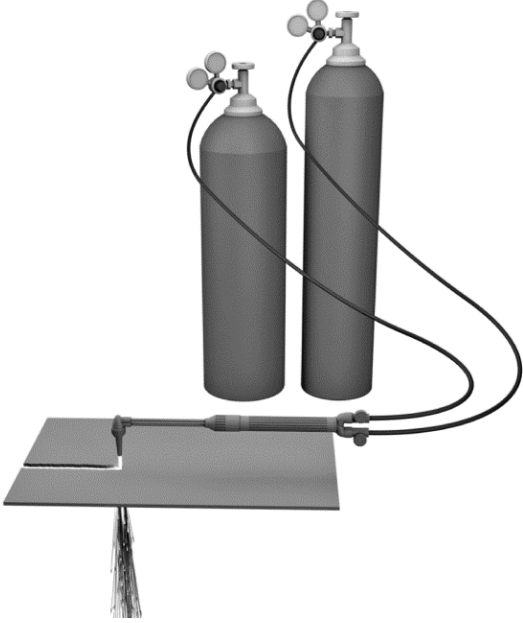



Welded Connections—  
A Primer for  
Engineers

150

### Thermal Cutting Processes: Plasma Cutting

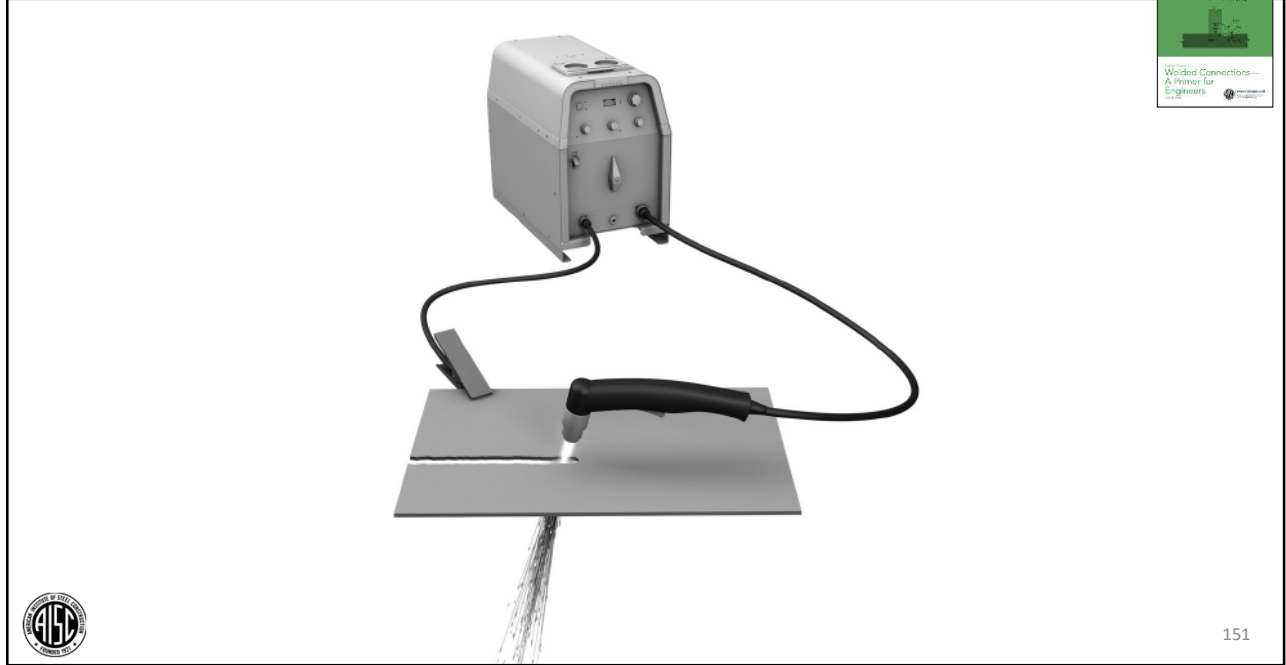

### Thermal Cutting Processes: Air Arc Gouging

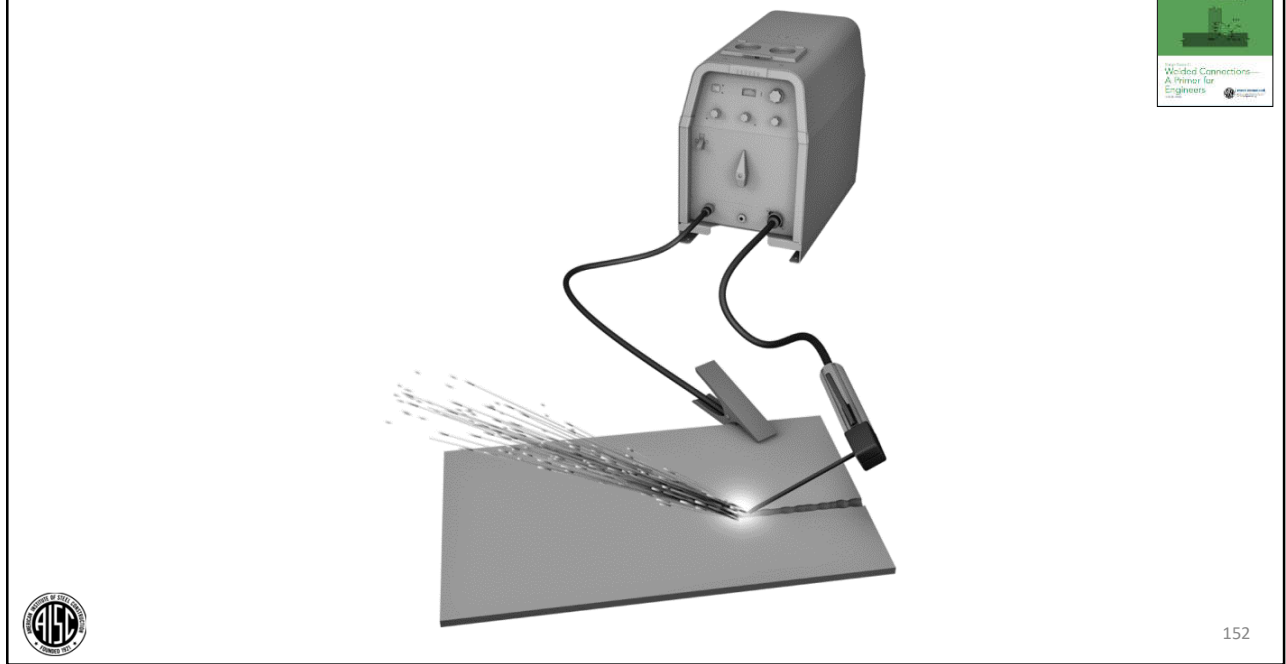

## Cutting Process: Water jet cutting



- Used pressurized stream of water to cut material
- Automated and accurate
- No oxidized surface and no heat affected zone (HAZ)
- More costly and not normally used in steel fabrication
- Permitted by AISC 360 (for cutting holes)



153

## Arc Welding Processes



**The selection of which process to use is typically best left up to those doing the welding.**

- Properly applied, all processes are capable of delivering quality welds
- Improperly applied, all processes may not deliver quality welds
- Mode of welding (manual, semiautomatic, automatic, robotic) will impact process selection
- Typically viewed as part of the Contractor's means and methods



154

## Arc Welding Processes



### Typical welding process applications:

- **GMAW:** for shop welding on clean parts; often the choice for robotic applications
- **FCAW-G:** for shop welding on steel with mill scale, rust
- **FCAW-S:** for field welding
- **SAW:** for big, long welds that lend themselves to automation
- **GTAW:** for special alloys, high quality welds, critical repairs
- **SMAW:** maintenance welding, field welding, tack welding, repair welding, miscellaneous fabrication



155

## WELDED CONNECTION BASICS

### Outline

- Applicable Codes
- Arc Welding Processes – Overview
- Welding and Thermal Cutting Processes
- ➔ • Joints and Weld Types



156

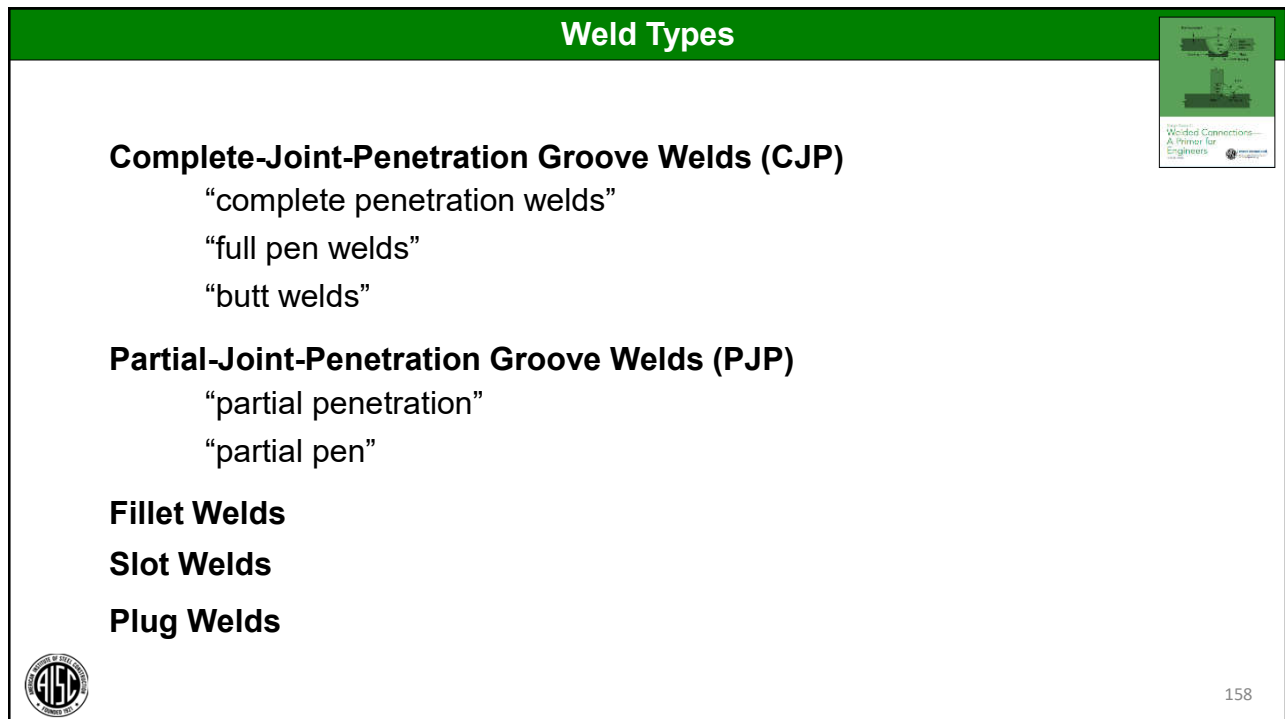
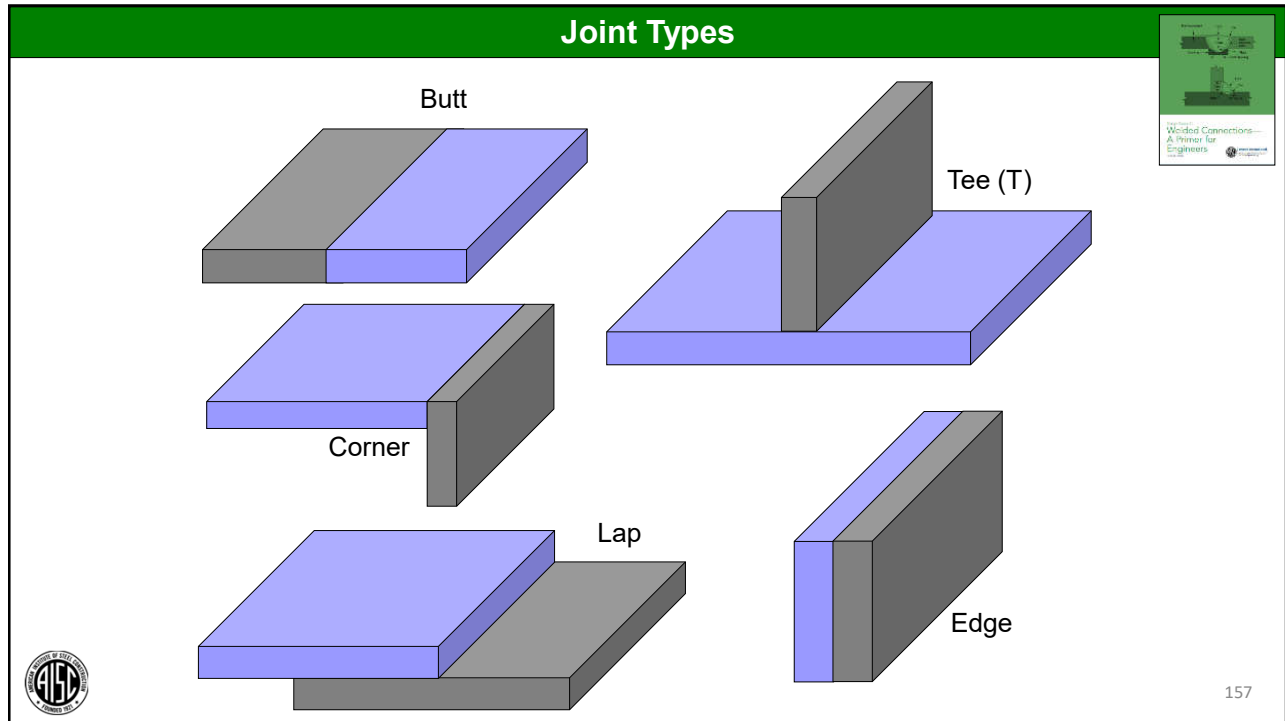

**Weld Types**

**CJP Groove Weld in Butt Joint**

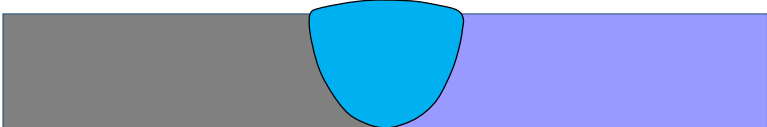

The diagram shows two horizontal bars, one grey on the left and one purple on the right, joined at their ends. A blue, semi-circular weld bead is positioned at the center of the joint, filling the gap between the two bars. The weld bead is wider than the gap it fills.

Welded Connections—  
A Primer for  
Engineers



159

**Weld Types**

**PJP Groove Weld in Butt Joint**

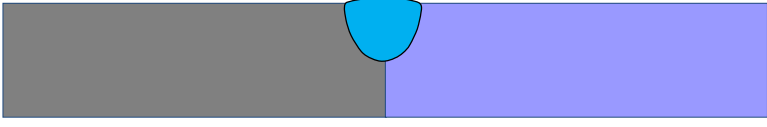

The diagram shows two horizontal bars, one grey on the left and one purple on the right, joined at their ends. A blue, semi-circular weld bead is positioned at the center of the joint, filling the gap between the two bars. The weld bead is narrower than the gap it fills.

Welded Connections—  
A Primer for  
Engineers





160

### Weld Types

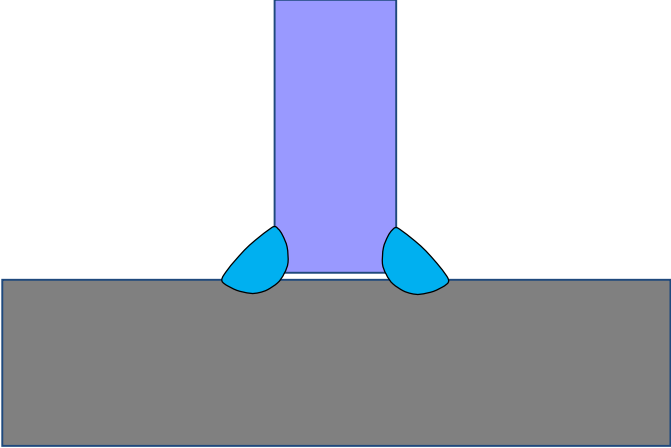
#### Fillet Weld in Tee Joint



The diagram shows a vertical purple rectangular member welded to a horizontal grey rectangular member. Two blue, teardrop-shaped welds are shown at the intersection, one on each side of the vertical member's base. The welds are convex on the outside and concave on the inside.





161

### Weld Types

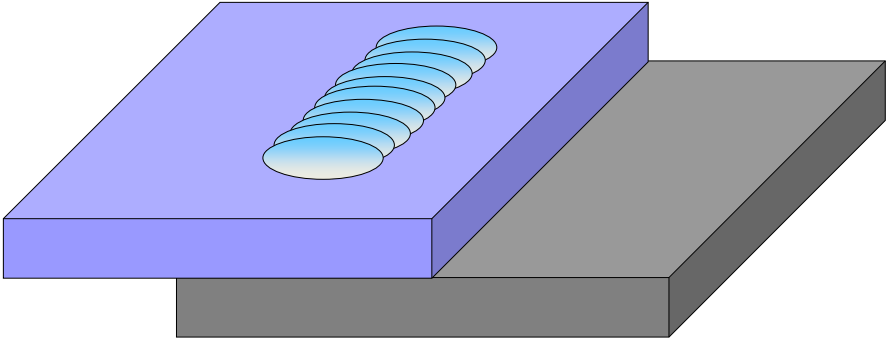
#### Slot Weld in Lap Joint



The diagram shows two overlapping rectangular plates. The top plate is purple and the bottom plate is grey. A series of blue, overlapping, teardrop-shaped welds are shown along the length of the overlap, representing a slot weld.



162

### Weld Types

#### Plug Weld in Lap Joint

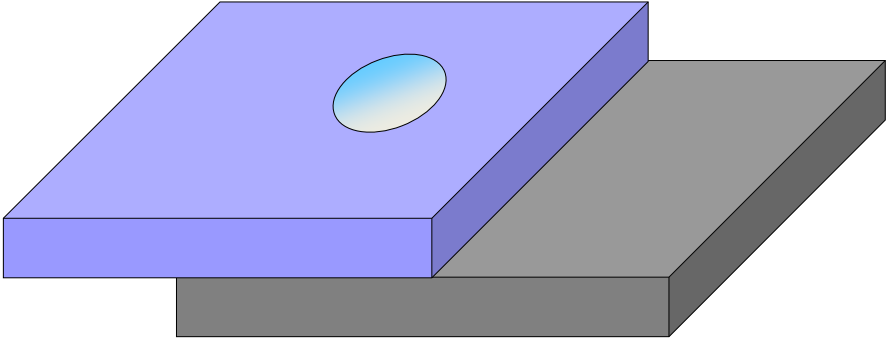

Welded Connections—  
A Primer for  
Engineers



163

### Weld Types

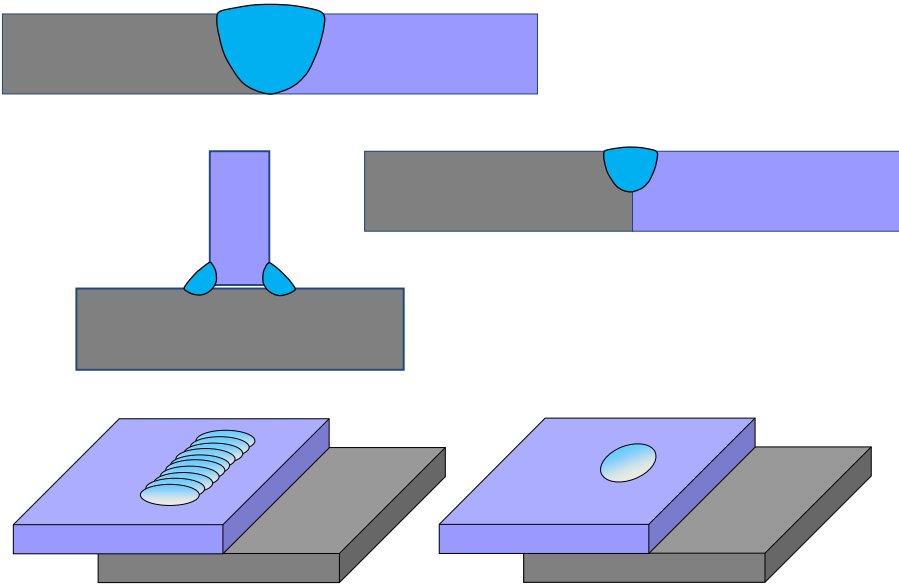

Welded Connections—  
A Primer for  
Engineers



164

## Groove Welds



- Applied to butt, tee, corner joints
- CJP = full strength (for statically loaded connections)
- PJP = partial strength
- Tension vs. compression vs. shear



165

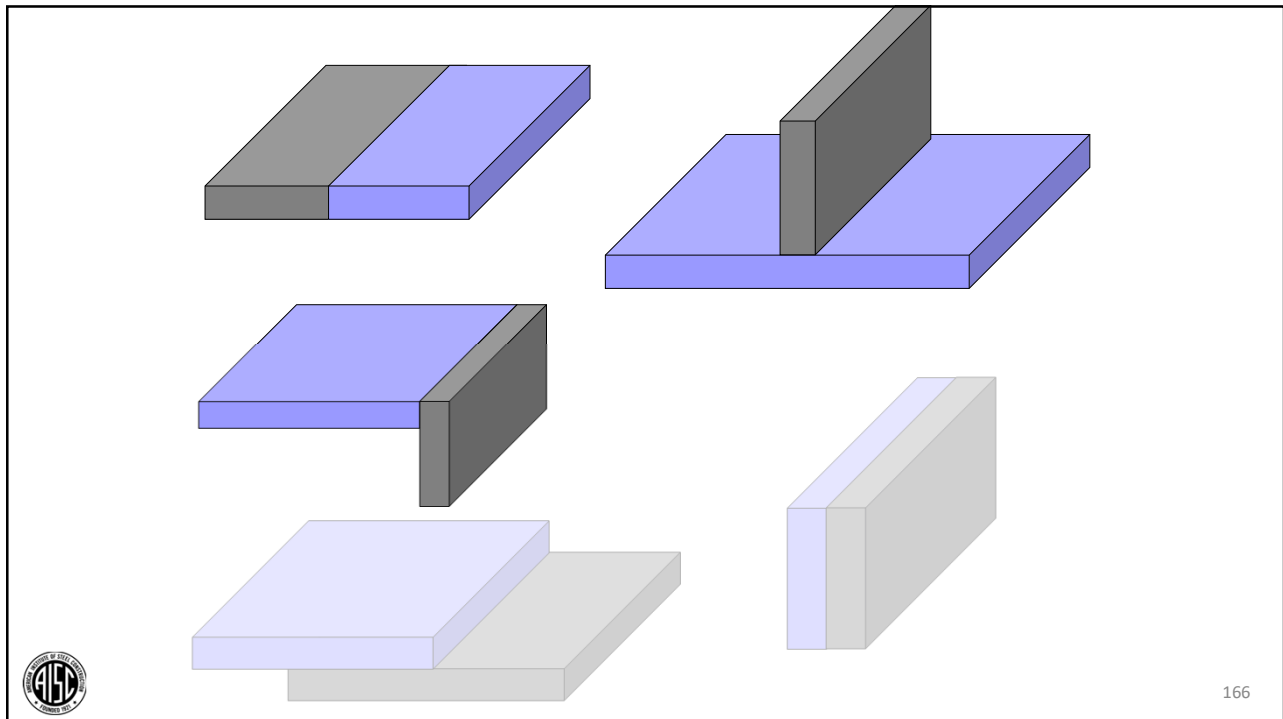

166

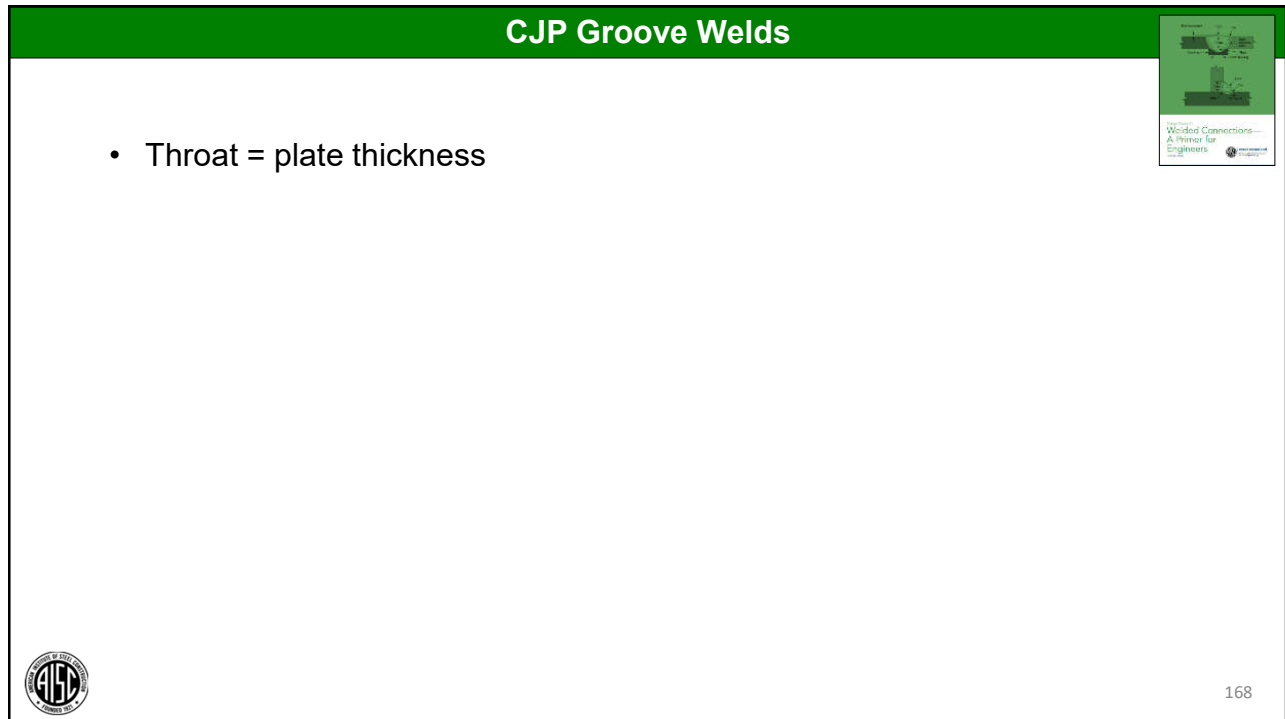
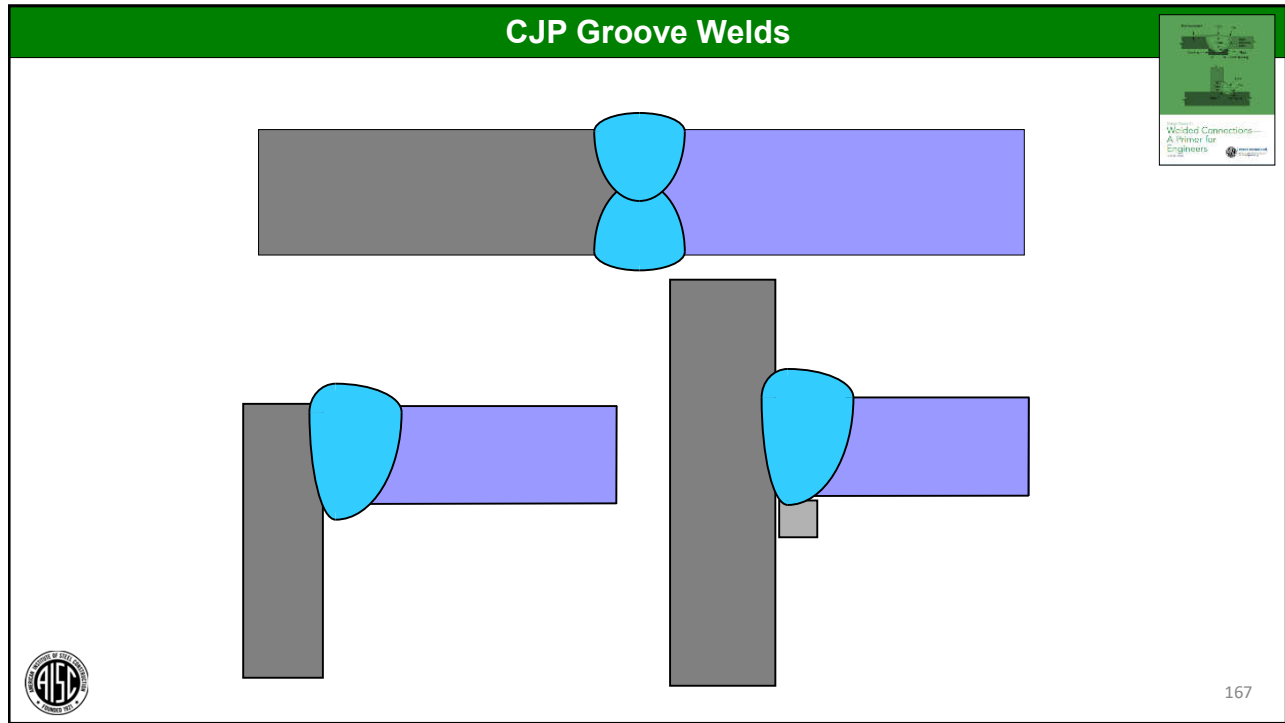

### CJP Groove Welds

**Weld Throat Dimension ( $t_w$ )**

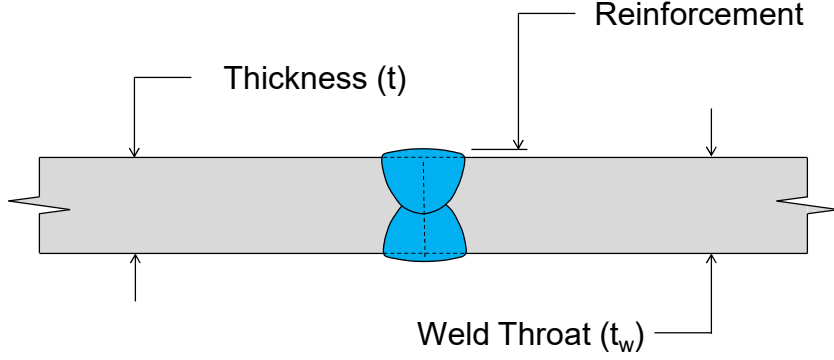



The diagram illustrates a CJP Groove Weld. Two gray plates of thickness  $t$  are joined by a blue weld. The weld throat is labeled  $t_w$ . A reinforcement is shown on the right side of the weld. The diagram is titled "Weld Throat Dimension ( $t_w$ )".

Thickness ( $t$ )

Reinforcement



Weld Throat ( $t_w$ )



169

### CJP Groove Welds

- Throat = plate thickness
- No design calculations are required for statically loaded connections, when “matching” filler metal is used



170



**CJP Groove Welds**

**Complete-Joint-Penetration Groove Weld (CJP)**

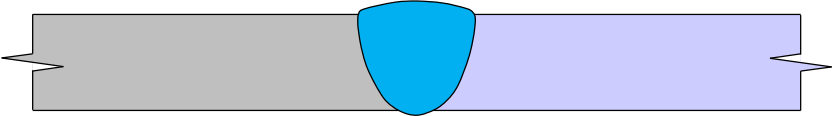
Single sided



The diagram shows two horizontal bars, one grey on the left and one light blue on the right, joined at their ends. A single blue weld bead is shown on the top surface of the joint, penetrating into the groove between the two bars. The bars have jagged ends on the far left and right, indicating they are part of a larger structure.



171



**CJP Groove Welds**

**Complete-Joint-Penetration Groove Weld (CJP)**

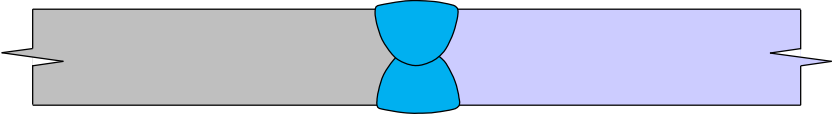
Double sided



The diagram shows two horizontal bars, one grey on the left and one light blue on the right, joined at their ends. Two blue weld beads are shown, one on the top surface and one on the bottom surface of the joint, both penetrating into the groove between the two bars. The bars have jagged ends on the far left and right, indicating they are part of a larger structure.



172



### CJP Groove Welds

**Complete-Joint-Penetration Groove Weld (CJP)**

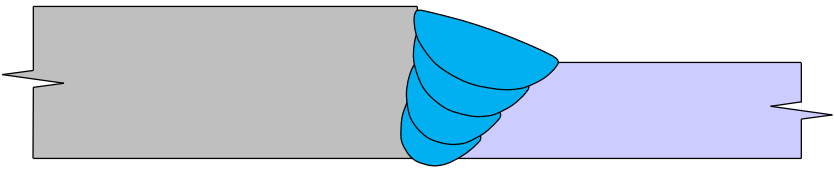
Two thicknesses



The diagram shows two horizontal plates of different thicknesses joined by a groove weld. The left plate is thicker and shaded gray, while the right plate is thinner and shaded light blue. A blue weld metal is shown filling the groove between the plates, with a jagged break on the right side of the thinner plate. The text 'Two thicknesses' is centered above the weld.



173



### CJP Groove Welds

**Complete-Joint-Penetration Groove Weld (CJP)**

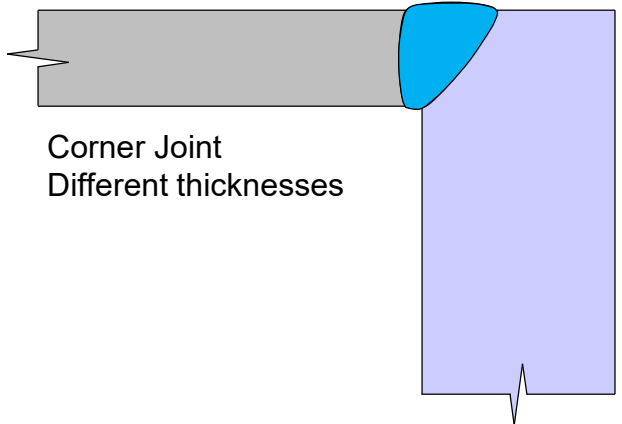
Corner Joint  
Different thicknesses



The diagram shows a corner joint where a horizontal plate of thickness 't' (shaded gray) meets a vertical plate of thickness 'T' (shaded light blue). A blue weld metal is shown filling the corner joint. A jagged break is shown on the bottom edge of the vertical plate. The text 'Corner Joint Different thicknesses' is centered to the left of the joint.



174

### CJP Groove Welds



Welded Connections—  
A Primer for  
Engineers

## Complete-Joint-Penetration Groove Weld (CJP)

Tee (T) joint

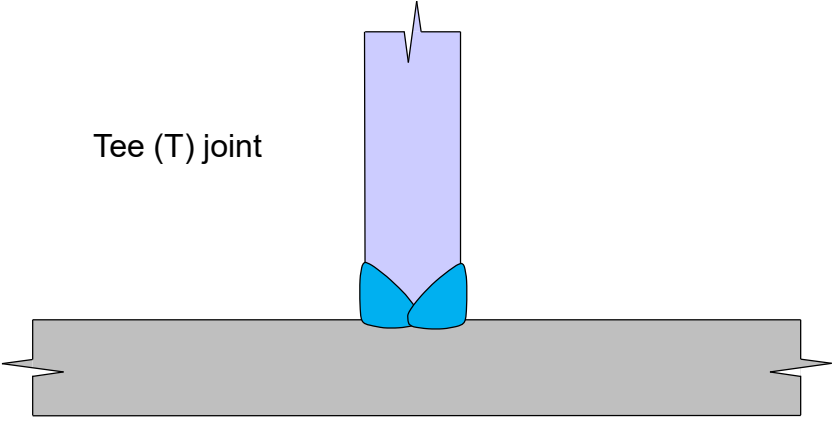

175

### CJP Groove Welds



Welded Connections—  
A Primer for  
Engineers

## Single Vee Groove Weld

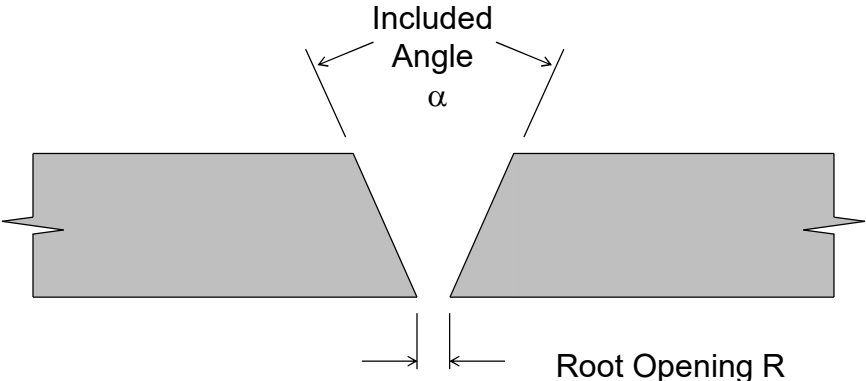

Included  
Angle  
 $\alpha$

Root Opening R





176

**CJP Groove Welds**

**Square Groove**



The diagram shows two gray rectangular steel plates positioned side-by-side. A square groove is cut into the top surface of both plates, meeting at a central vertical line. The groove has a 90-degree angle. The ends of the plates are shown with jagged, lightning-bolt-like shapes, indicating they are part of a larger assembly.





177

**CJP Groove Welds**

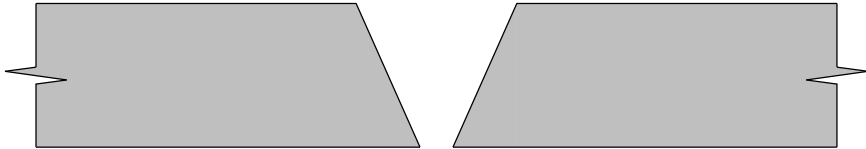
**Single Vee Groove**



The diagram shows two gray rectangular steel plates positioned side-by-side. A single Vee groove is cut into the top surface of both plates, meeting at a central vertical line. The groove has a V-shaped profile with a 60-degree angle. The ends of the plates are shown with jagged, lightning-bolt-like shapes, indicating they are part of a larger assembly.



178

### CJP Groove Welds



Welded Connections—  
A Primer for  
Engineers

## Single Bevel Groove

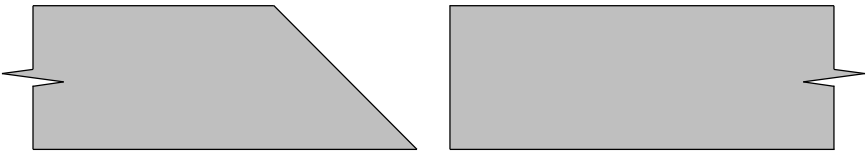

179

### CJP Groove Welds



Welded Connections—  
A Primer for  
Engineers

## Single J Groove

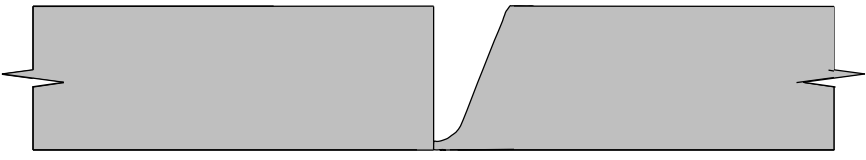



180

### CJP Groove Welds

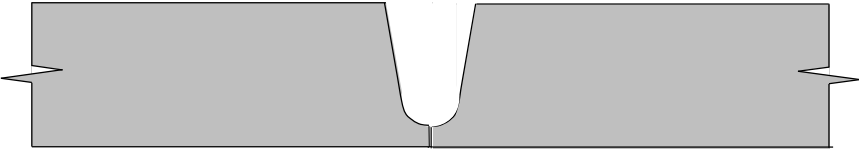
#### Single U Groove



The diagram shows a cross-section of two steel plates joined by a single U groove groove weld. The groove is U-shaped, and the weld metal is shown filling the groove. The plates are shaded gray, and the weld metal is white. The diagram is centered on the page.





181

### PJP Groove Welds

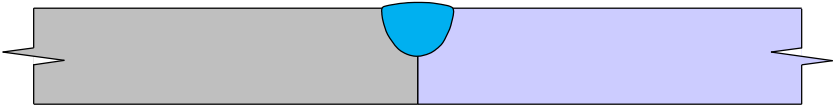
#### Single Sided PJP in Butt Joint



The diagram shows a cross-section of two steel plates joined by a single-sided PJP (Partial Joint Penetration) groove weld. The groove is semi-circular, and the weld metal is shown filling the groove. The plates are shaded gray and light blue, and the weld metal is light blue. The diagram is centered on the page.



182

**PJP Groove Welds**

**Double Sided PJP in Butt Joint**

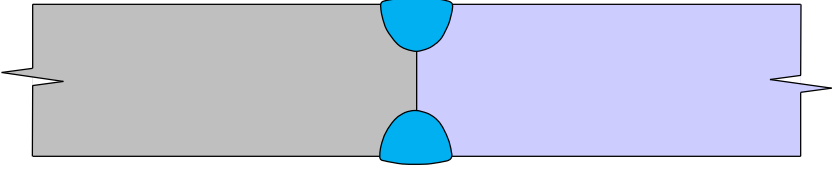

Welded Connections—  
A Primer for  
Engineers



183

**PJP Groove Welds**

**Single Sided PJP in Corner Joint**

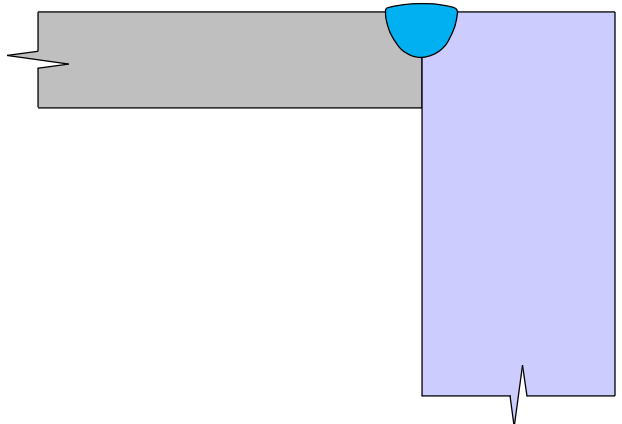

Welded Connections—  
A Primer for  
Engineers



184

### PJP Groove Welds



Welded Connections—  
A Primer for  
Engineers

### Double Sided PJP in Tee (T) Joint

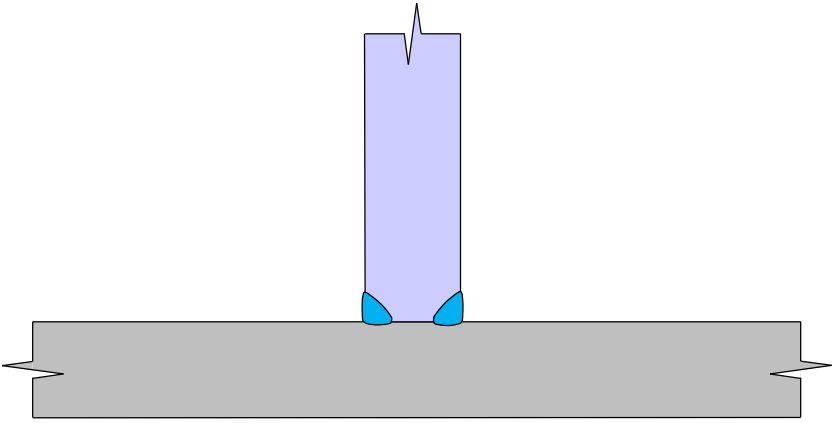

185

### PJP Groove Welds



Welded Connections—  
A Primer for  
Engineers

### Single Sided Vee PJP Groove Weld

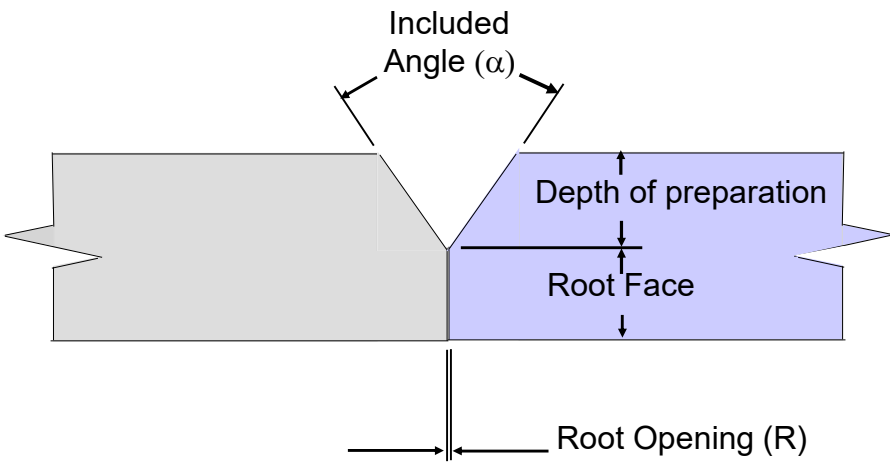

Included  
Angle ( $\alpha$ )

Depth of preparation

Root Face

Root Opening (R)



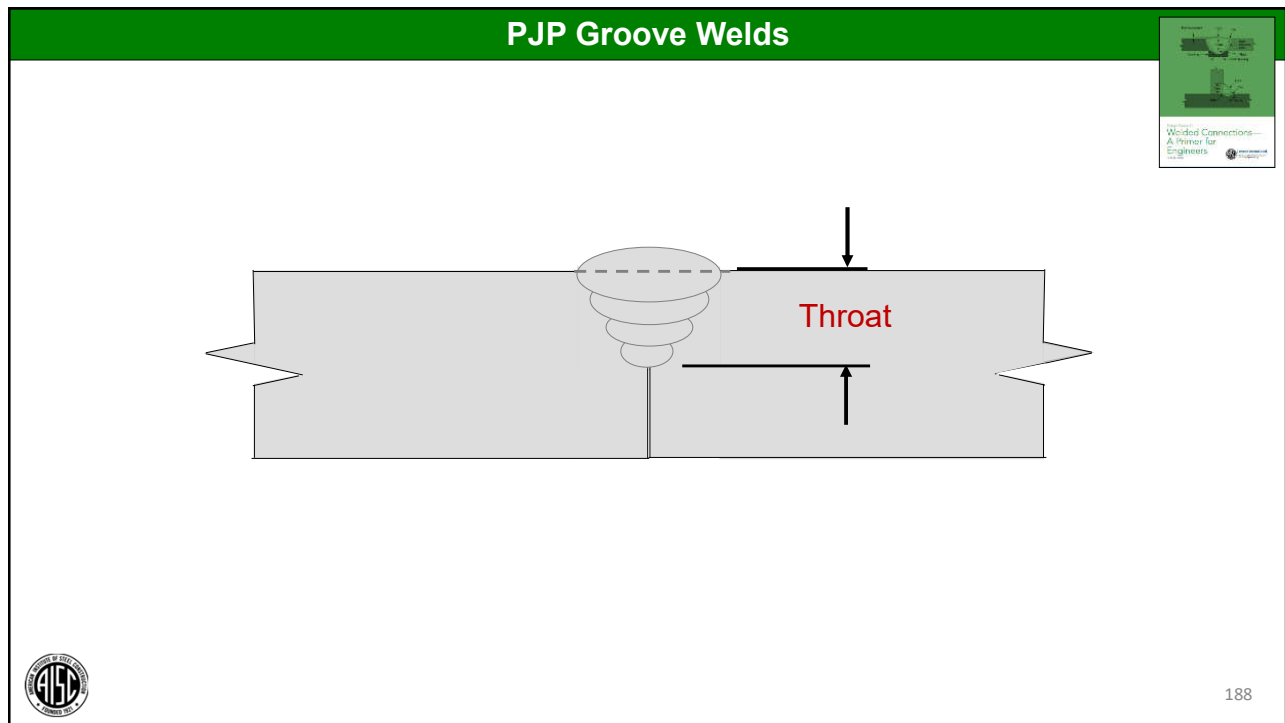
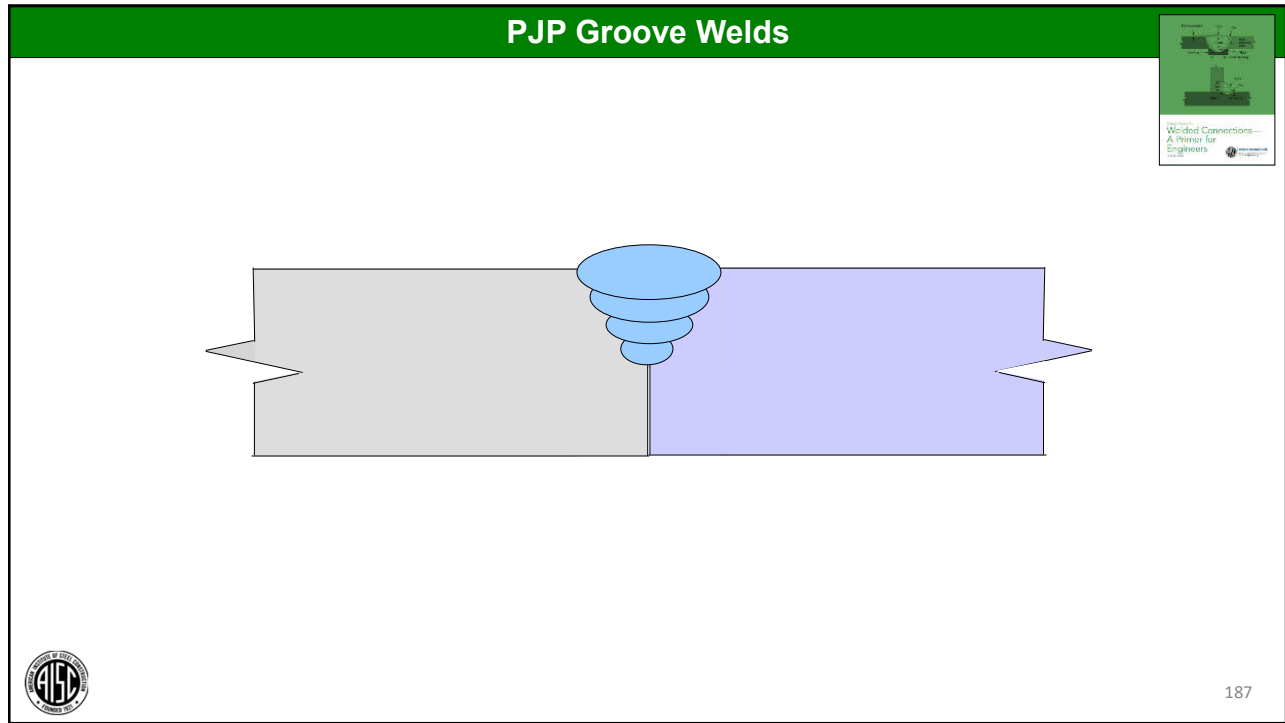

186





### PJP Groove Welds

- Throat < plate thickness
- Must determine throat



189

### Flare Vee Groove Welds

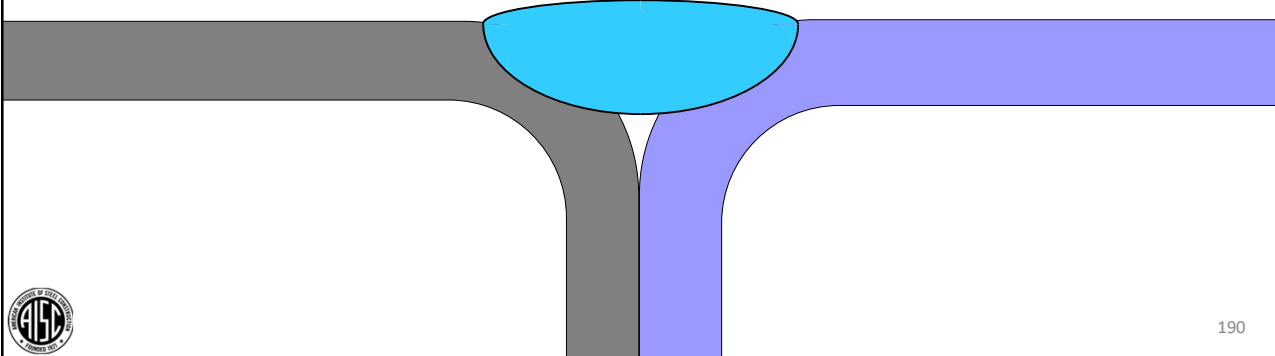

190

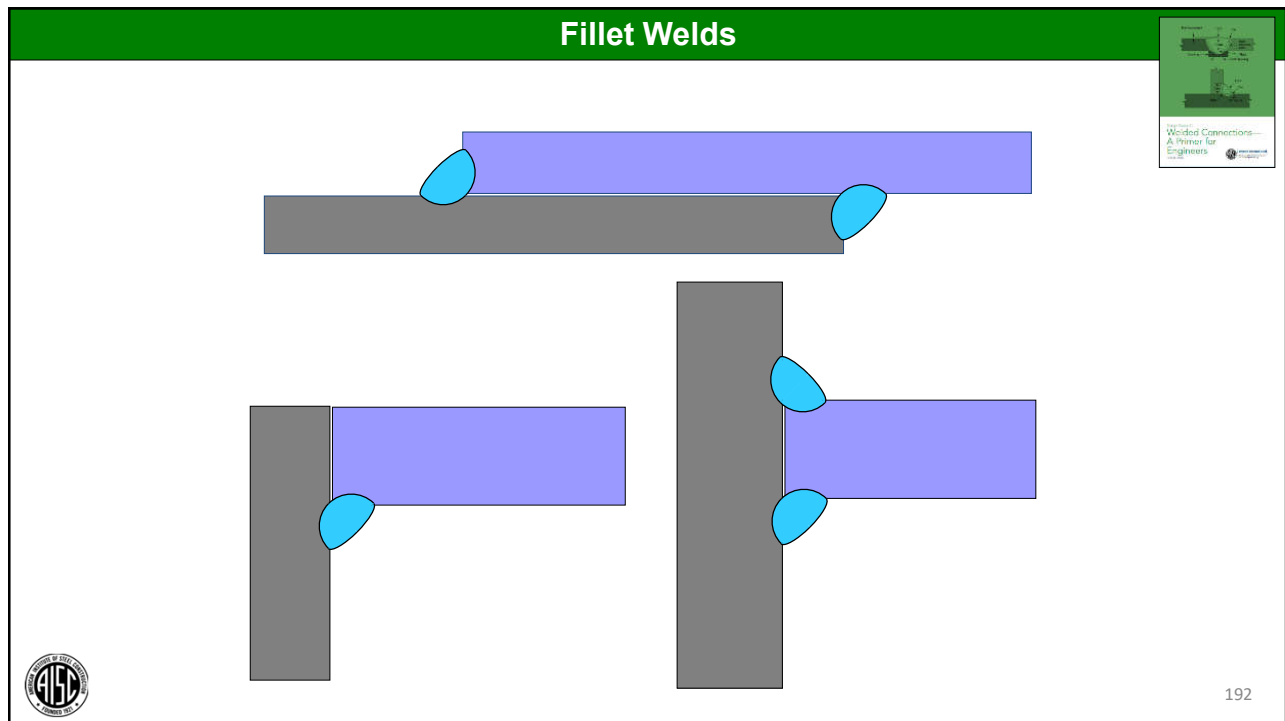
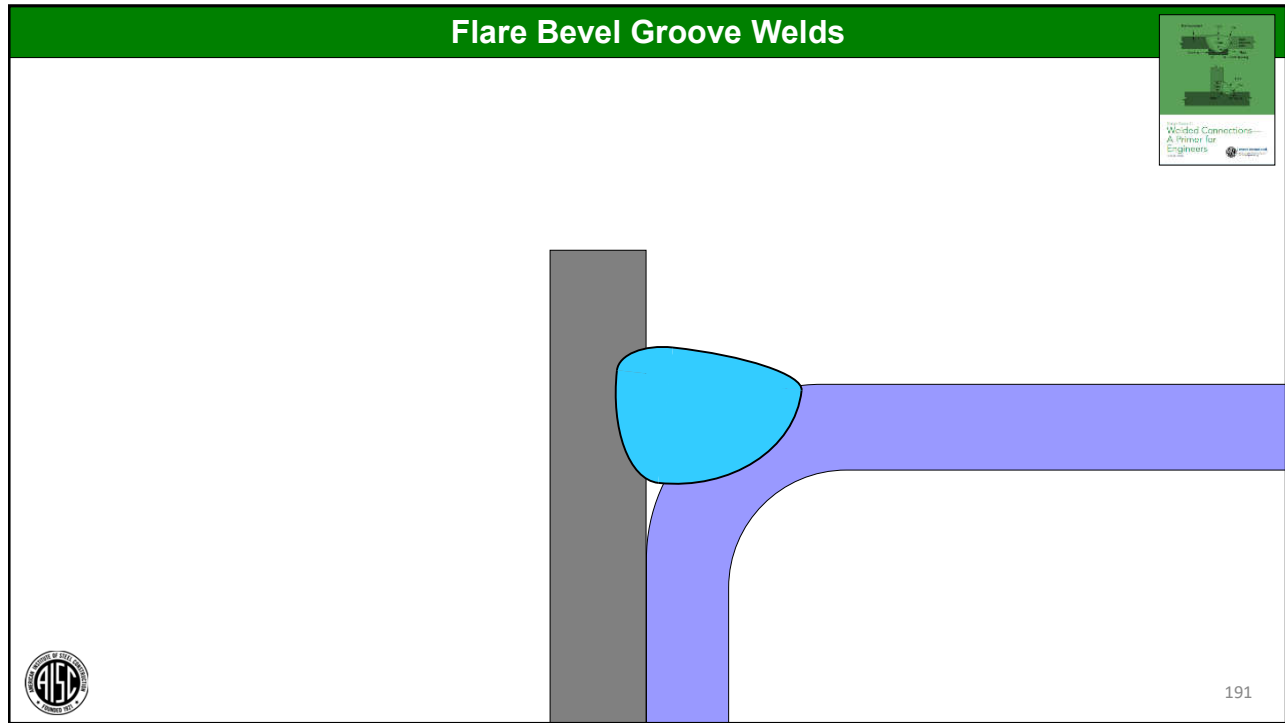

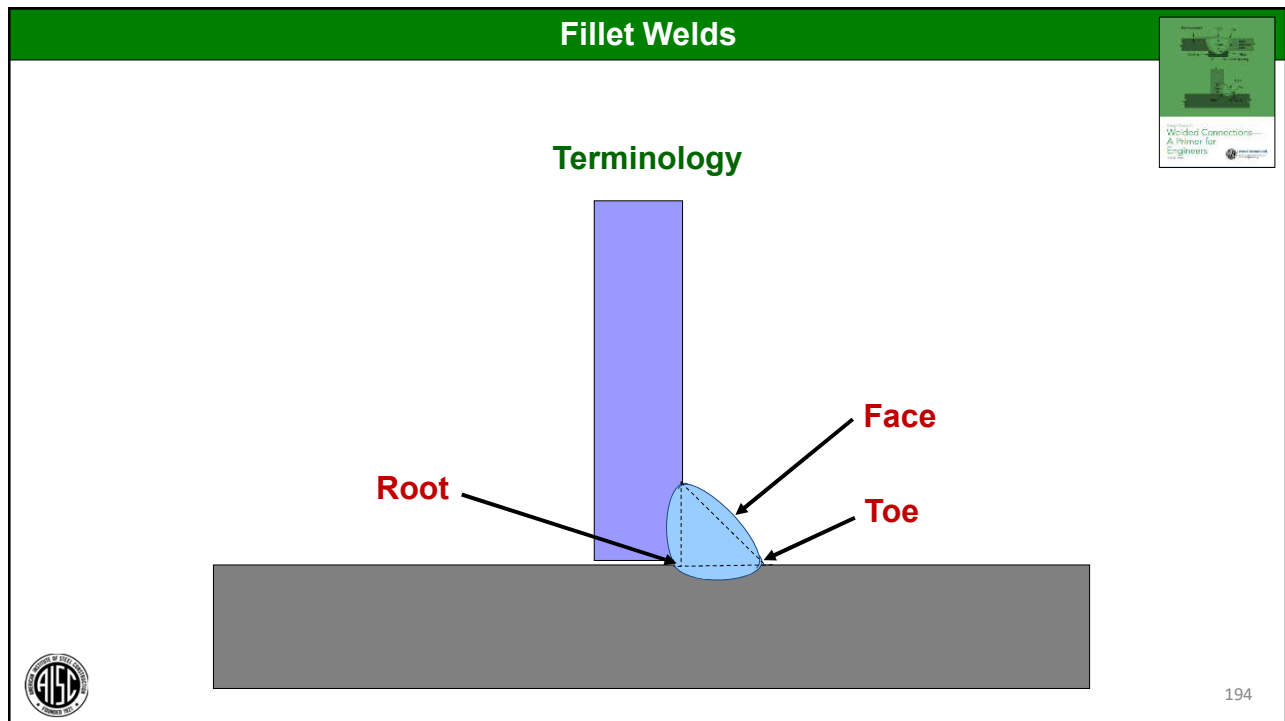
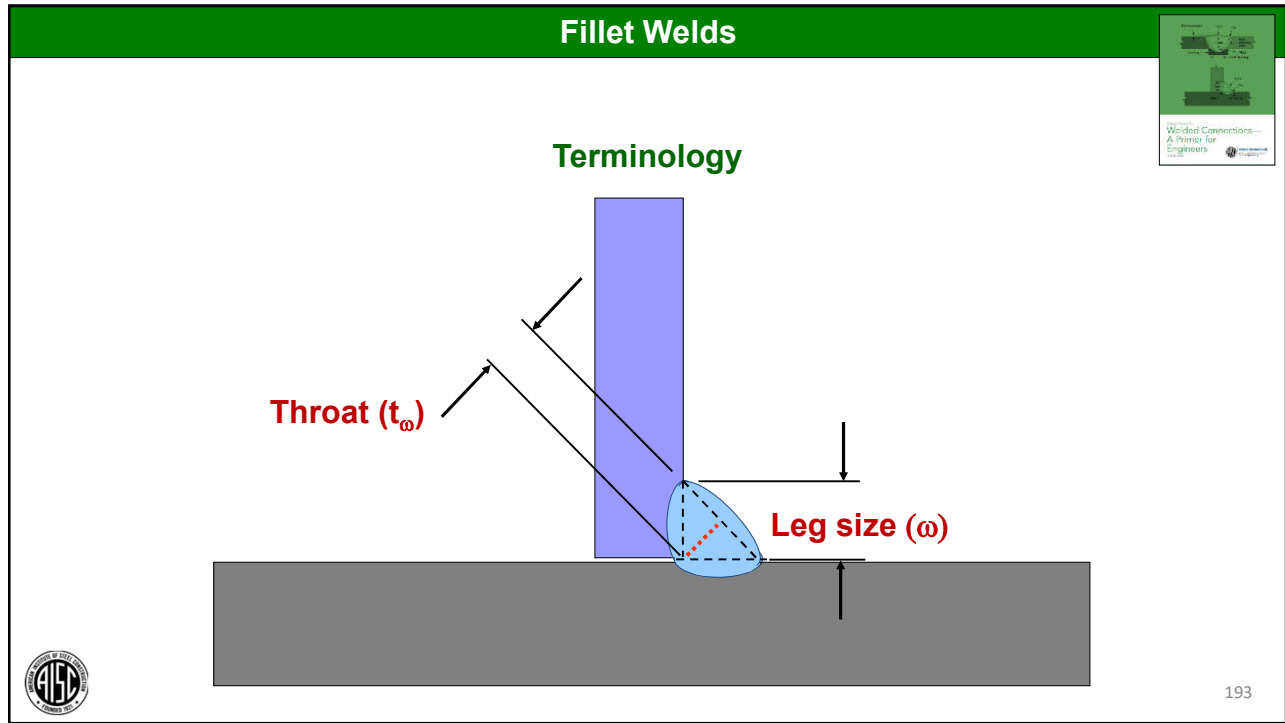

## Fillet Welds

- Applied to tee, corner, lap joints



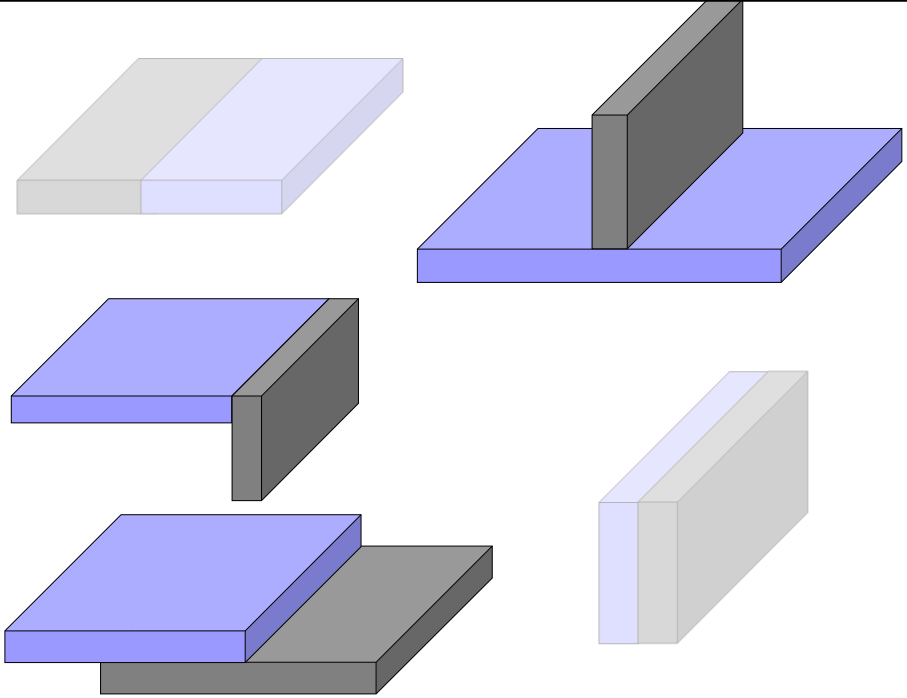

195



196



### Fillet Welds

- Applied to tee, corner, lap joints
- Specify leg (throat) dimension
- Specify length



197

### Plug and Slot Welds

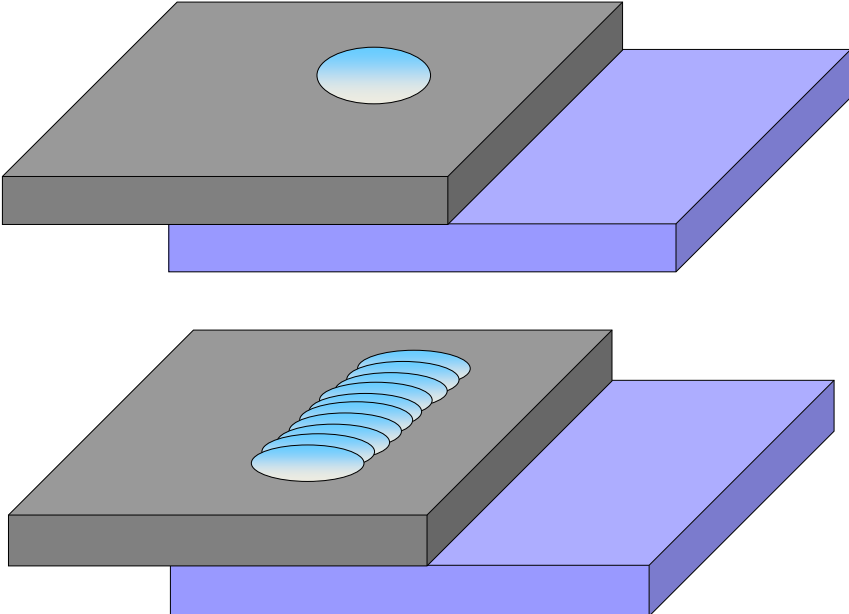

198

## Plug and Slot Welds

- Applied to lap joints

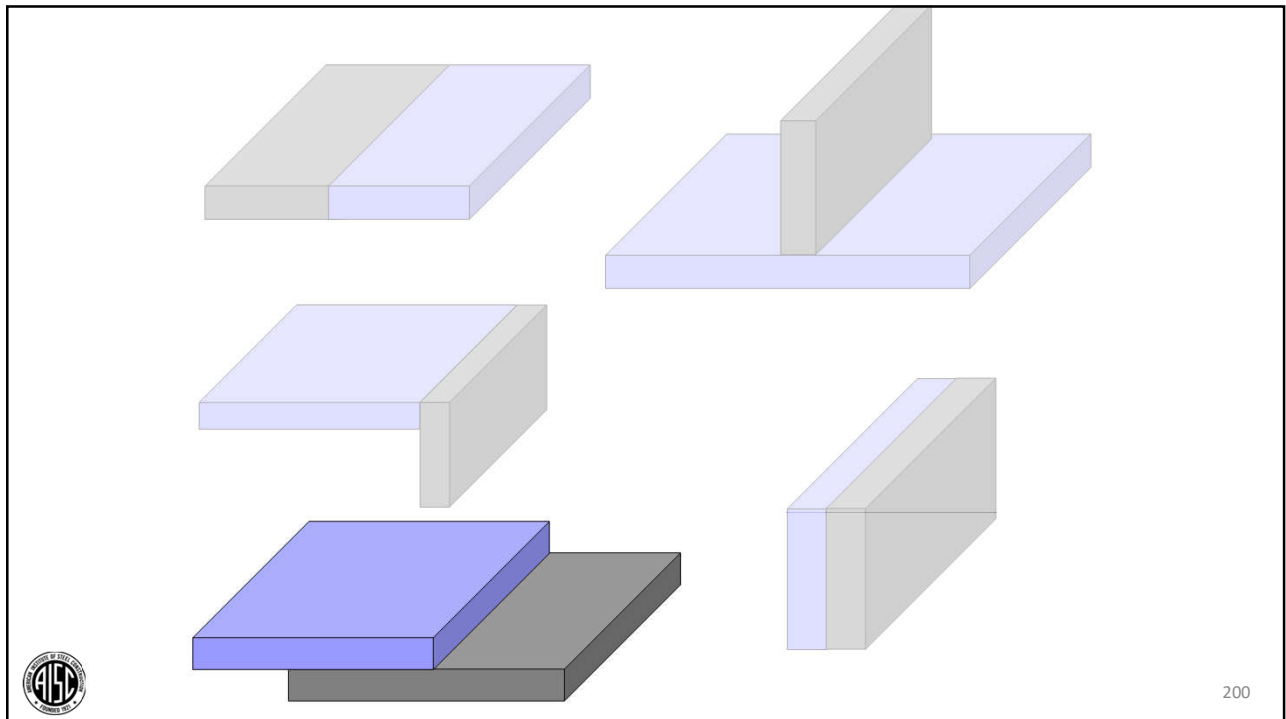

## Plug and Slot Welds

- Applied to lap joints
- Not often applied in structures
- Restricted capacity in cyclically loaded structures



201

## WELDED CONNECTION BASICS

### Outline

- Applicable Codes
- Arc Welding Processes – Overview
- Welding and Thermal Cutting Processes
- Joints and Weld Types



202

# Thank you!

**AISC** | Questions



## Individual Session Registrants

---

### PDH Certificates

- All WFH individuals associated with a group registration will be issued a certificate.
- All individuals attending at your connection: you will receive an email on how to report their attendance from: [registration@aisc.org](mailto:registration@aisc.org).
  - Be on the lookout: Check your spam filter! Check your junk folder!
  - Completely fill out online form. Don't forget to check the boxes next to each attendee's name!



## 8-Session Registrants

---

### PDH Certificates

One certificate will be issued at the conclusion of all 8 sessions.



## 8-Session Registrants

---

### Access to the quiz

Information for accessing the quiz will be emailed to you by Thursday. It will contain a link to access the quiz. EMAIL COMES FROM [NIGHTSCHOOL@AISC.ORG](mailto:NIGHTSCHOOL@AISC.ORG).

### Quiz and attendance records

Posted Thursday mornings. [www.aisc.org/nightschool](http://www.aisc.org/nightschool) -- Click on Current Course Details.

### Reasons for quiz

- EEU – You must take all quizzes and the final exam to receive EEU.
- PDHs – If you watch a recorded session, you must pass quiz for PDHs.
- REINFORCEMENT – Reinforce what you learn tonight. Get more out of the course.

*Note: If you attend the live presentation, you do not have to take the quizzes to receive PDHs*



## 8-Session Registrants

---

### Access to the recording

Information for accessing the recording will be emailed to you by Thursday. The recording will be available for four weeks. (For 8-session registrants only.) EMAIL COMES FROM [NIGHTSCHOOL@AISC.ORG](mailto:NIGHTSCHOOL@AISC.ORG).

### PDHs via recording

If you watch a recorded session, you must take *and pass* the quiz for PDHs.



## 8-Session Registrants

---

### Night School Resources

Find all your handouts, quizzes and quiz scores, recording access, and attendance information all in one place!



## 8-Session Registrants

### Night School Resources

Go to [www.aisc.org](http://www.aisc.org) and sign in.

EDUCATION PUBLICATIONS NASCC: THE STEEL CONFERENCE SAFETY STEEL SOLUTIONS CENTER AWARDS AND COMPETITIONS RESEARCH LIBRARY

**AISC**

**Login**  
If you're an existing customer, please enter your username and password.

**USERNAME**  
Enter your username

**PASSWORD**  
Enter your password

Remember Me

**DON'T HAVE AN ACCOUNT?**  
My AISC allows you to access Engineering Journal articles and Design Guides you have downloaded from the bookstore.

**REGISTER NOW**

## 8-Session Registrants

### Night School Resources

Go to [www.aisc.org](http://www.aisc.org) and sign in.

**IN THIS SECTION**

- Edit Profile
- My Downloads
- My Pending Quizzes
- My Events
- Order History
- Course History
- Course Resources

**MyAISC**

**MY PROFILE**  
Update your contact and address information.

**EDIT PROFILE**

**MY PURCHASED DOWNLOADS**  
Access articles and documents that you have purchased.

**VIEW DOWNLOADS**

**MY COURSE RESOURCES**  
View online resources for Night School and Live Webinar package registrat

**VIEW RESOURCES**

# 8-Session Registrants

## Night School Resources



### Course Resources

Event	Start Date
NS 13 8-Session Package-Night School 13 - Design of Industrial Buildings	1/30/2017 7:00:00 PM
NS 14 8-Session Package-Night School 14 - Fundamentals of Stability	6/5/2017 7:00:00 PM

# 8-Session Registrants

## Night School Resources



### Night School 13: Design of Industrial Buildings

#### 8-SESSION PACKAGE RESOURCES

Event	Date	Handouts	Video	Quiz	Attendance
NS13 - Design Criteria	1/30/2017 7:00:00 PM	<a href="#">Handouts</a>	<a href="#">View</a> Passcode: NS13D5N	Pass Score: 80	Pending
NS13 - Economic Considerations	2/6/2017 7:00:00 PM	<a href="#">Handouts</a>	Available 02/08/2017 5pm EST	Available 02/08/2017 5pm EST	Pending
NS13 - Lateral Load Systems and Details	2/13/2017 7:00:00 PM	<a href="#">Handouts</a>	Available 02/15/2017 5pm EST	Available 02/15/2017 5pm EST	Pending
NS13 - Preliminary Design Procedures	2/27/2017 7:00:00 PM	<a href="#">Handouts</a>	Available 03/01/2017 5pm EST	Available 03/01/2017 5pm EST	Pending
NS13 - Crane Girder Design and Frame Analysis	3/6/2017 7:00:00 PM	<a href="#">Handouts</a>	Available 03/08/2017 5pm EST	Available 03/08/2017 5pm EST	Pending
NS13 - Frame Member and Connection Design	3/13/2017 7:00:00 PM	<a href="#">Handouts</a>	Available 03/15/2017 5pm EST	Available 03/15/2017 5pm EST	Pending
NS13 - Transfer Crane Girder & Longitudinal Bldg Bracing Dsn	3/27/2017 7:00:00 PM	<a href="#">Handouts</a>	Available 03/29/2017 5pm EST	Available 03/29/2017 5pm EST	Pending
NS13 - Building Envelope and Bracing Design	4/3/2017 7:00:00 PM	<a href="#">Handouts</a>	Available 04/05/2017 5pm EST	Available 04/05/2017 5pm EST	Pending

## 8-Session Registrants

---

### Night School Resources

- Weekly “quiz and recording” email.
- Weekly updates of the master quiz and attendance record, found at [www.aisc.org/nightschool26](http://www.aisc.org/nightschool26). Scroll down to Quiz and Attendance records.
  - Updated on Friday mornings.



## 8-Session Registrants

---

### Night School Resources

- Webinar connection information
  - Reminder email sent out Tuesday mornings
- Links to handouts also found here



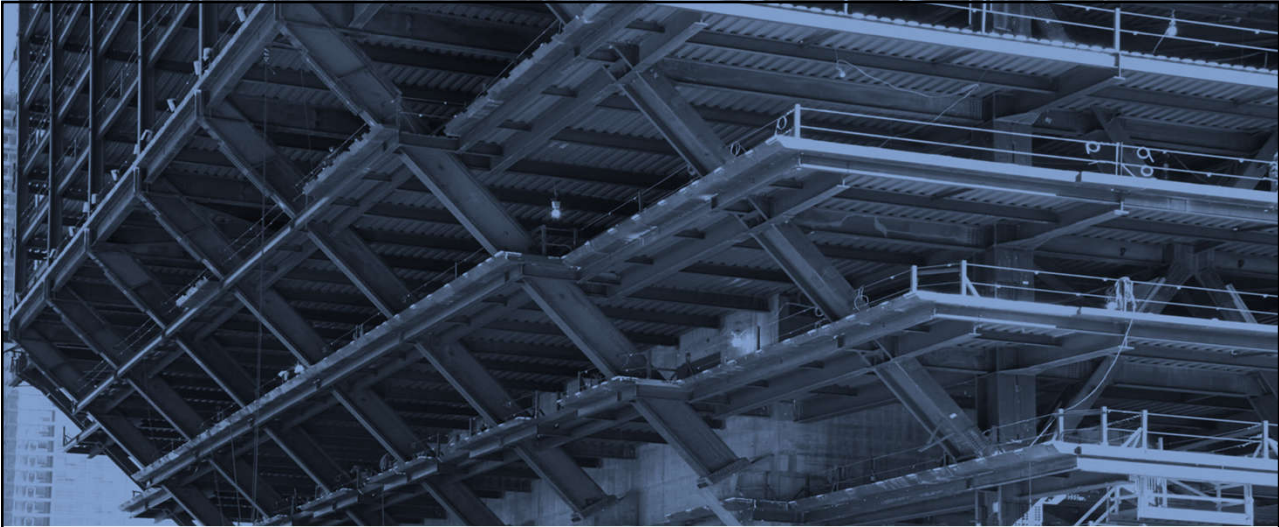

**AISC** | Thank you

